



# ReTree Interior Doors

We do care! No- Return!



# Content

- I. Stile Deluxe:
  - I.1. Massive: Massive Deluxe & Massive Forte
  - I.2. Fine Veneer
  
- II. Nova Flush:
  - II.1. Nova Veneered: Plain & Grooved
  - II.2. Nova Color: Plain & Grooved
  
- III. Press Plus:
  - III.1. Veneered
  - III.2. Colored
  
- IV. Concept Door:
  - IV.1. Shaker Light: Veneered & Colored
  - IV.2. Thierry Door
  - IV.3. White Tulip
  
- V. Frame System:
  - V.1. Trim & Fix
  - V.2. Adjustable
  
- VI. Warranty



# STILE DELUXE (SD)



MASSIVE (SD-M)

MASSIVE DELUXE (SD-MD)

## Stile & Rails:

- Core: finger-jointed hardwood
- Base: sawn hardwood
- Faces: 0,6mm quarter-cut veneer
- Edge: 8-25mm solid hardwood
- Moulding: solid hardwood

## Panels:

- Core: 18mm edge-joined solid panels
- Faces: no
- Glazed: removable solid hardwood moulding
- Moulding: angled profile possible

## Wood selection:

- Wood species: white & red oak, teak, black walnut, cherry, pine
- Grading: max. 3 sound knots of max. 20mm allowed, no other natural defects on each side allowed
- Color: uniform color within 1 door

## Dimensions:

- ▶ Height: 1800-2200mm
- ▶ Width: 600-1100mm
- ▶ Thickness: 32-45mm

## Models:

see overview on a separate page

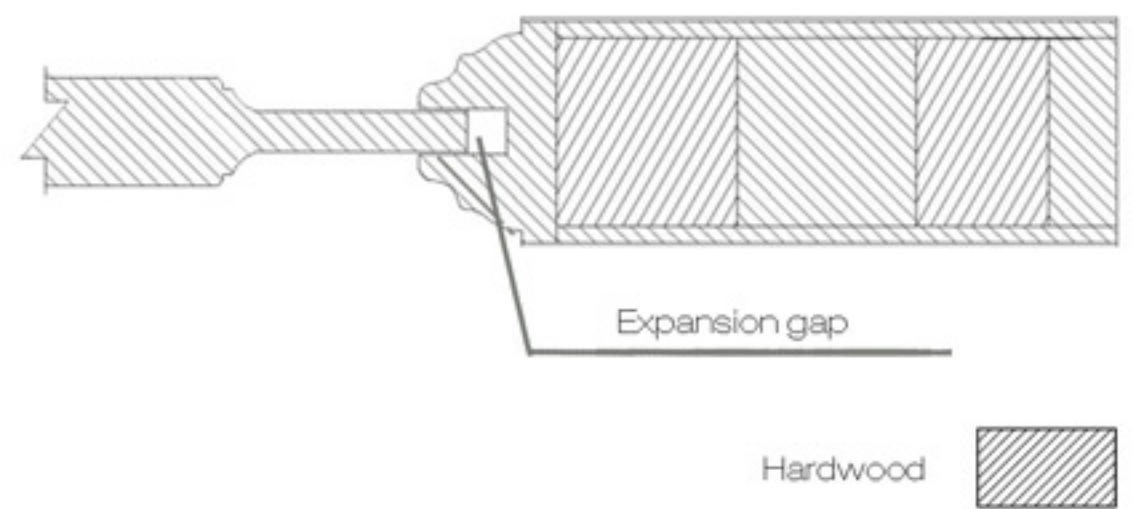
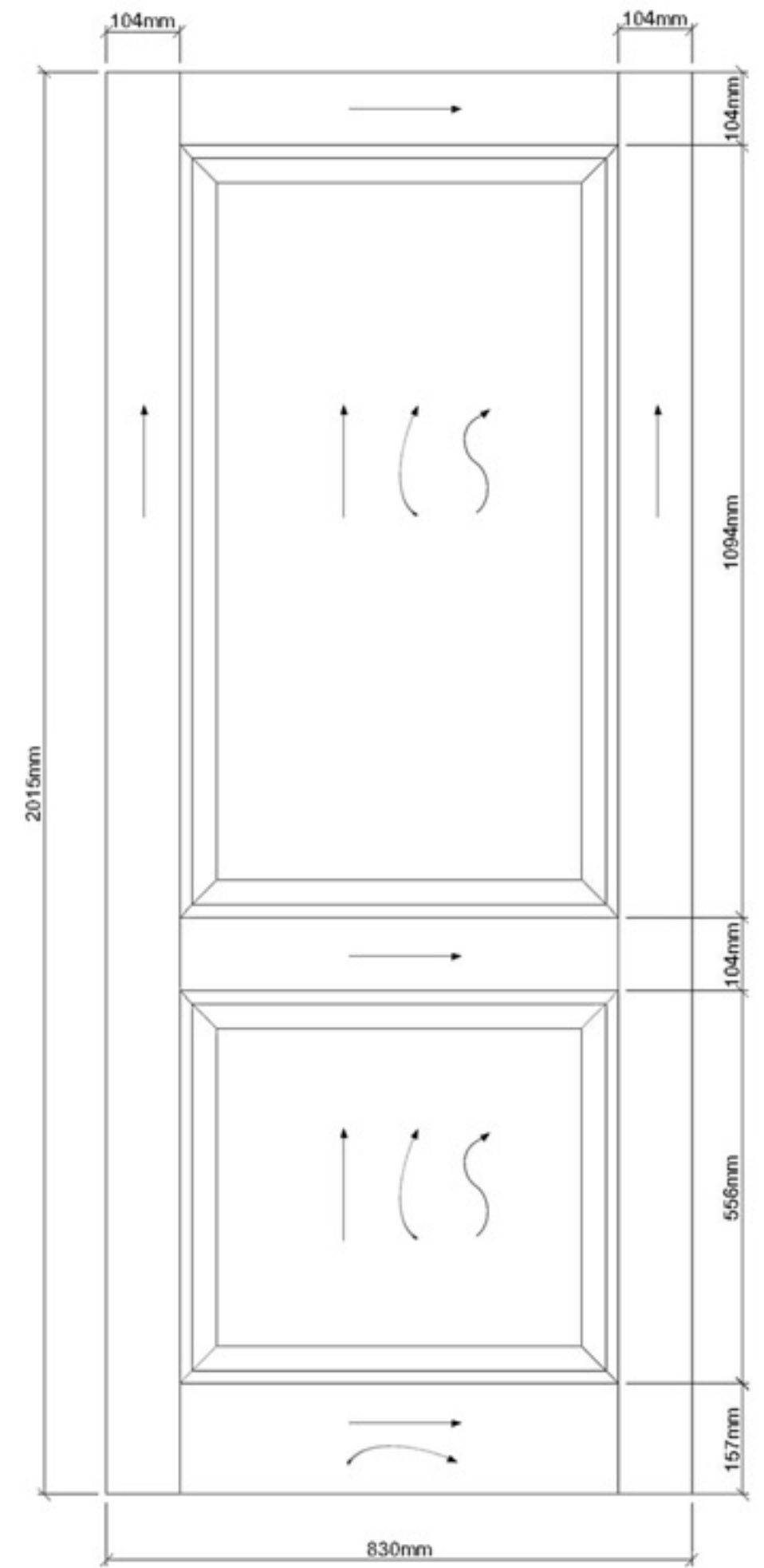

## ADDED VALUES:

### Pre-drilling:

- Lock, handle, hinges (left-right, reversible)

### Finishing:

- Oil, wax oil
- PU lacquer: ▶ open grain/ closed grain
  - ▶ matt/ high gloss
  - ▶ stained

[Selected high quality finishing possible through our Belgian production site]

### Packing:

- Retail packing/ warehouse packing
- Labeling, branding (OEM), bar coding



# STILE DELUXE (SD)

MASSIVE (SD-M)

MASSIVE FORTE (SD-MF)

## Stile & Rails:

- Core: finger-jointed softwood
- Base: MDF (density = 780 kg/cbm)
- Faces: 0,6mm quarter-cut veneer
- Edge: 8-25mm solid hardwood
- Moulding: solid hardwood

## Panels:

- Core: 18mm edge-jointed solid panels
- Faces: no
- Glazed: removable solid hardwood moulding
- Moulding: angled profile possible

## Wood selection:

- Wood species: white & red oak, teak, black walnut, cherry, pine
- Grading: max. 5 natural defects of max. 20mm are allowed on each face
- Color: uniform color within 1 door

## Dimensions:

- ▶ Height: 1800-2300mm
- ▶ Width: 600-1100mm
- ▶ Thickness: 32-45mm

## Models:

see overview on a separate page

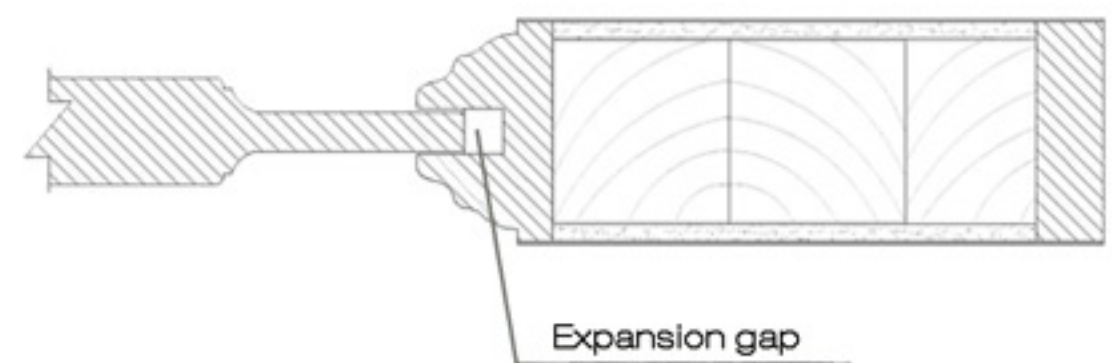
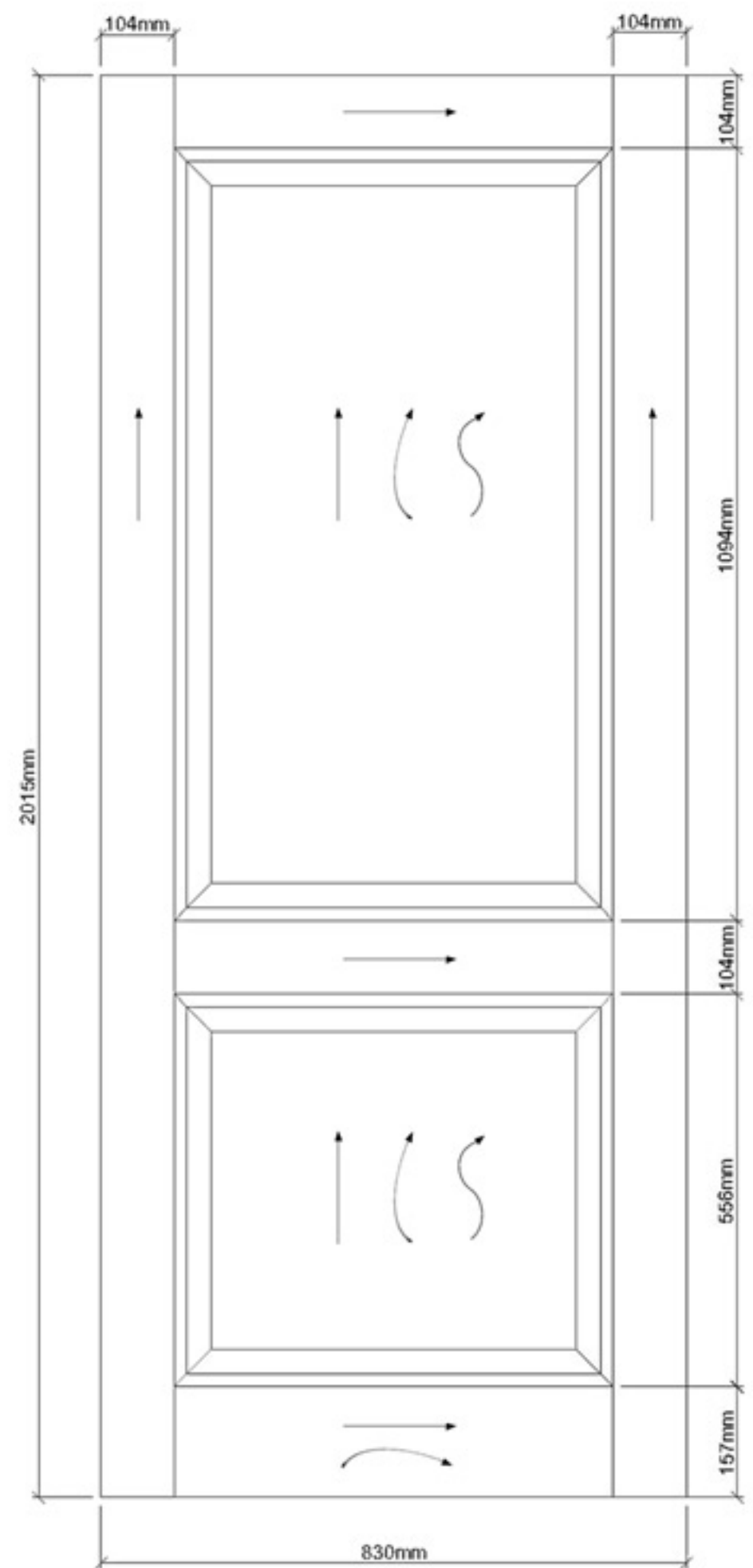

## ADDED VALUES:

### Pre-drilling:

- Lock, handle, hinges (left-right, reversible)

### Finishing:

- Oil, wax oil
- PU lacquer:
  - ▶ open grain/ closed grain
  - ▶ matt/ high gloss
  - ▶ stained

[Selected high quality finishing possible through our Belgian production site]

### Packing:

- Retail packing/ warehouse packing
- Labeling, branding (OEM), bar coding

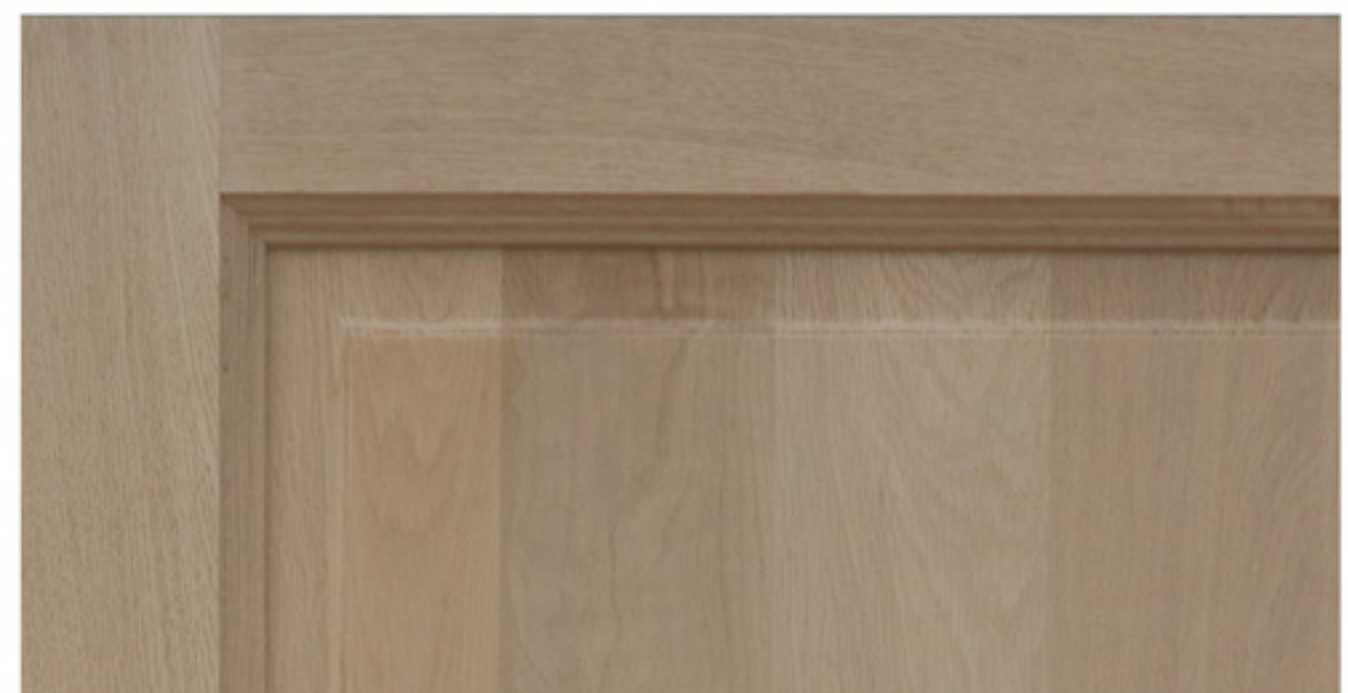

# STILE DELUXE (SD)

## MASSIVE (SD-M) - MODELS

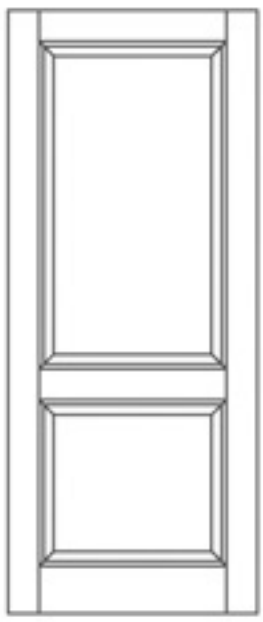

SD-M01

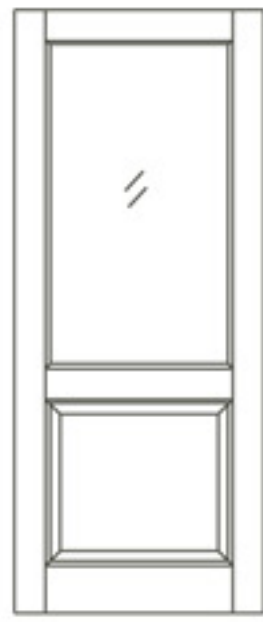

SD-M02



SD-M03



SD-M04

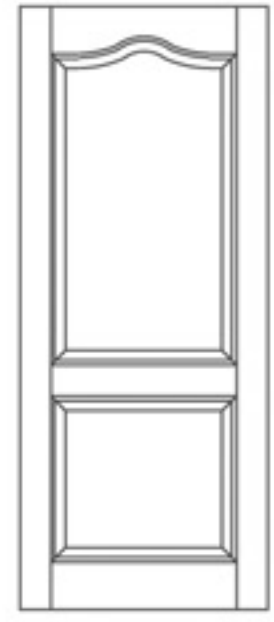

SD-M05



SD-M06

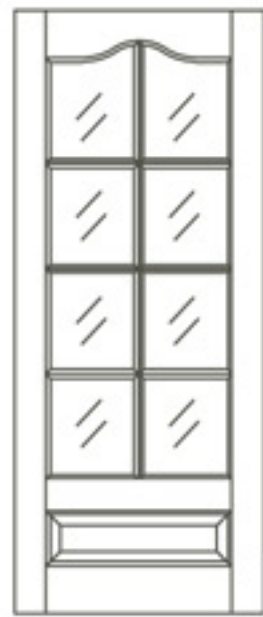

SD-M07

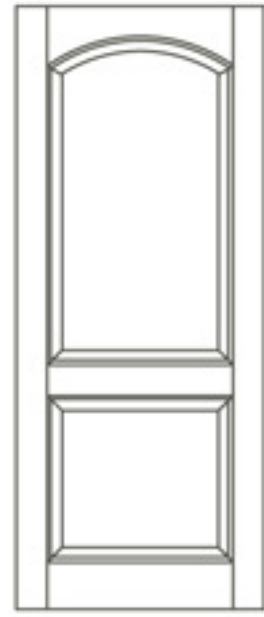

SD-M08



SD-M09

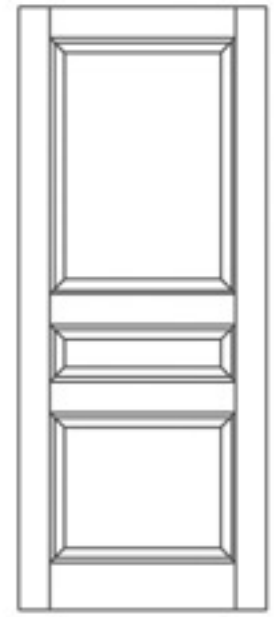

SD-M10

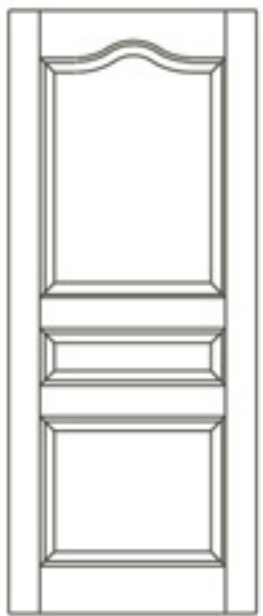

SD-M11



SD-M12



SD-M13

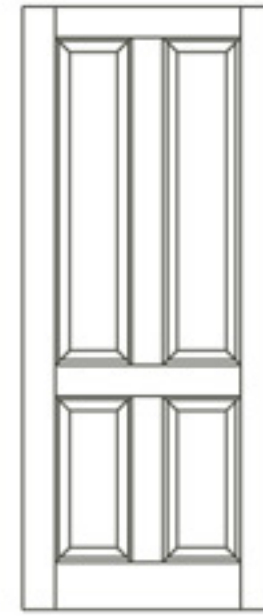

SD-M14



SD-M15



SD-M16



SD-M17

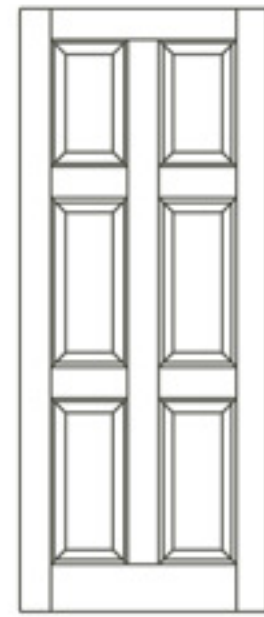

SD-M18

# STILE DELUXE (SD)

## FINE VENEER (SD-FV)

### Stile & Rails:

- Core: finger-jointed softwood
- Base: MDF (density = 780 kg/cbm)
- Faces: 0,6mm quarter-cut veneer
- Edge: 3-10mm solid hardwood
- Moulding: MDF veneered / solid hardwood

### Panels:

- Core: 18mm MDF (density = 780 kg/cbm)
- Faces: 0,6mm quarter cut veneer, book match veneer
- Glazed: removable solid hardwood moulding
- Moulding: lightly curved, shaker squared

### Wood selection:

- Wood species:
  - ▶ Genuine veneers: white & red oak, teak, black walnut, cherry, pine
  - ▶ Engineered veneers
- Grading: A-grade selected veneers
- Color: uniform color within 1 pallet (25-28 doors)

### Dimensions:

- ▶ Height: 1800-2400mm
- ▶ Width: 600-1200mm
- ▶ Thickness: 32-45mm

### Models:

see overview on a separate page

### ADDED VALUES:

#### Pre-drilling:

- Lock, handle, hinges (left-right, reversible)

#### Finishing:

- Oil, wax oil
- PU lacquer:
  - ▶ open grain/ closed grain
  - ▶ matt/ high gloss
  - ▶ stained

[Selected high quality finishing possible through our Belgian production site]

#### Packing:

- Retail packing/ warehouse packing
- Labeling, branding (OEM), bar coding

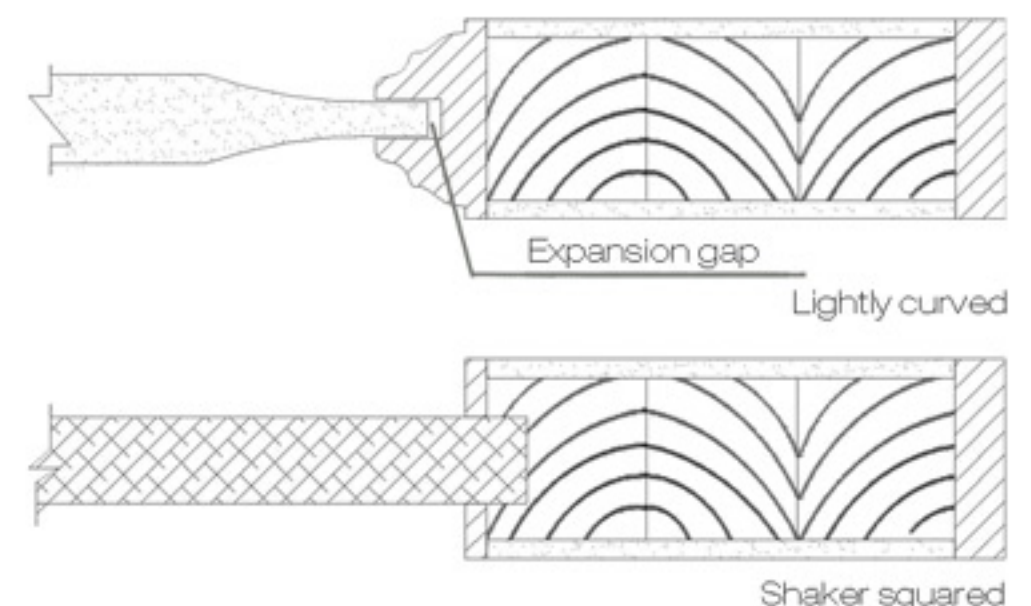
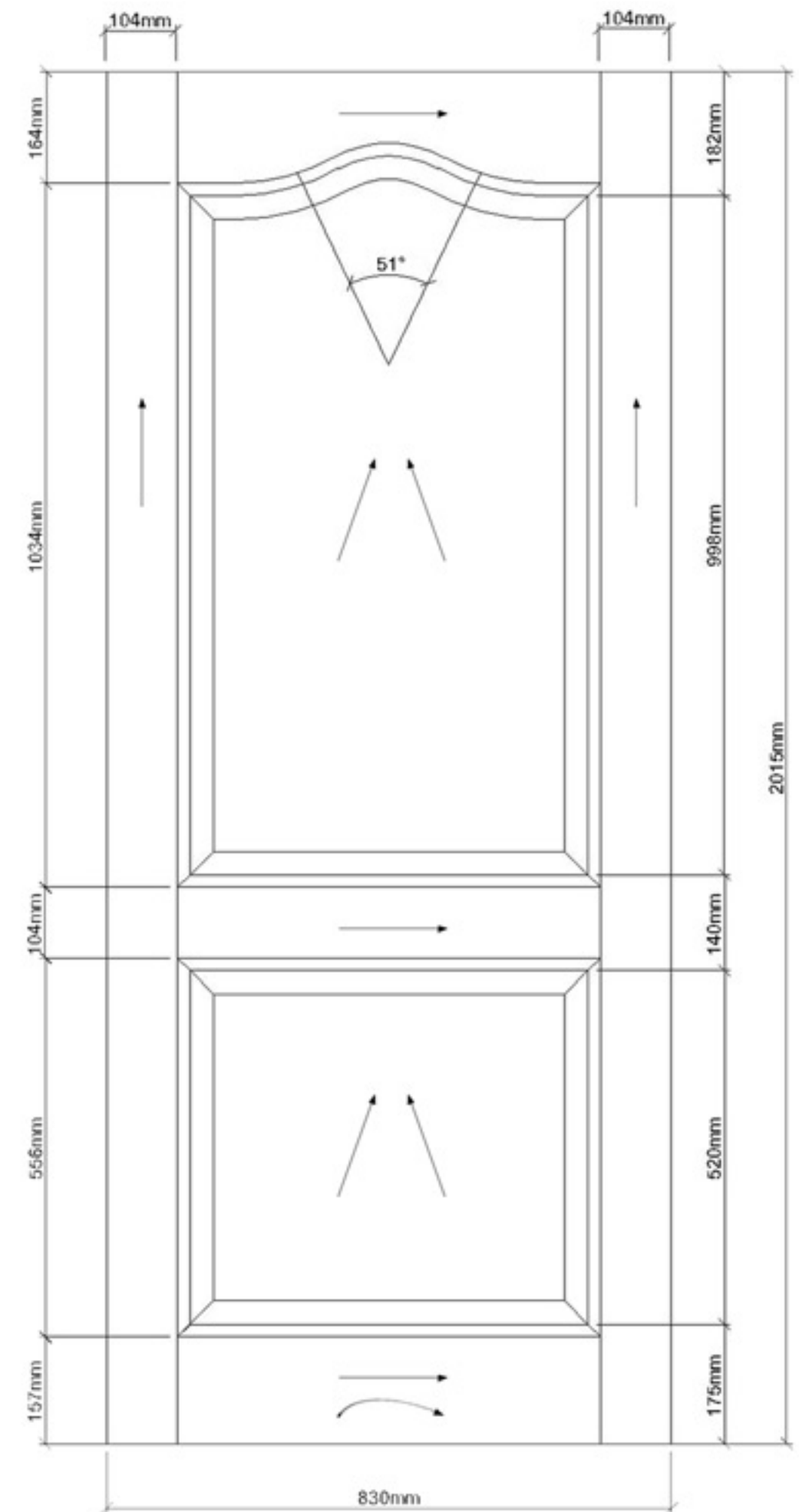

# STILE DELUXE (SD)

## FINE VENEER (SD-FV) - MODELS

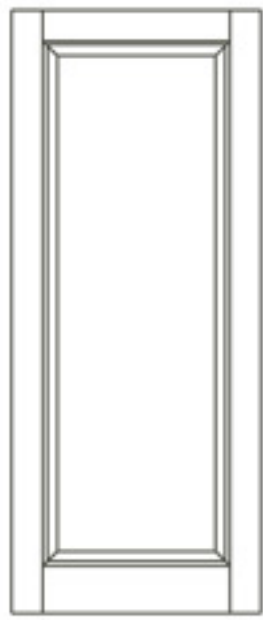

SD-FV01

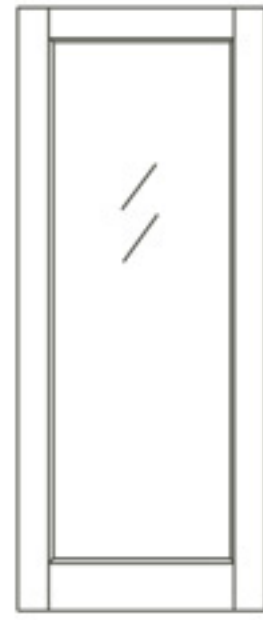

SD-FV02

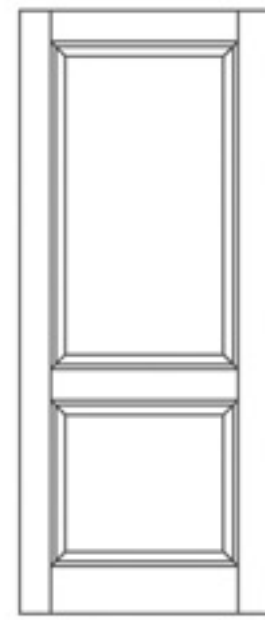

SD-FV03

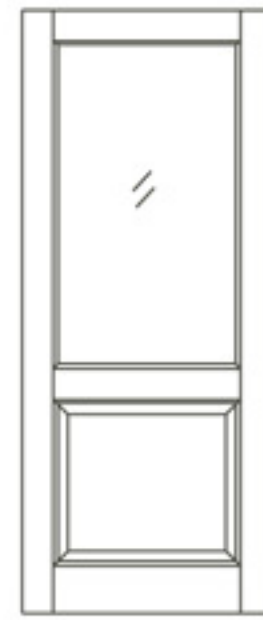

SD-FV04



SD-FV05



SD-FV06

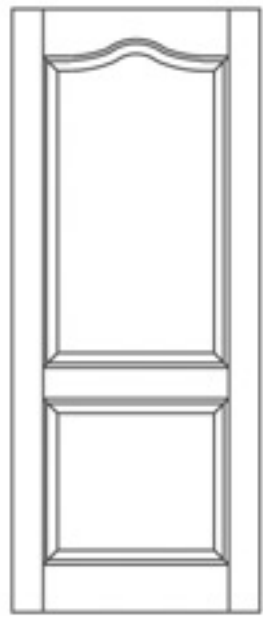

SD-FV07



SD-FV08



SD-FV09

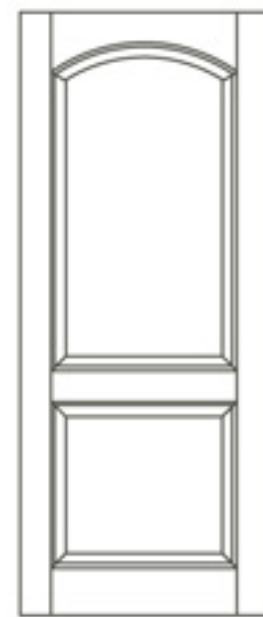

SD-FV10



SD-FV11

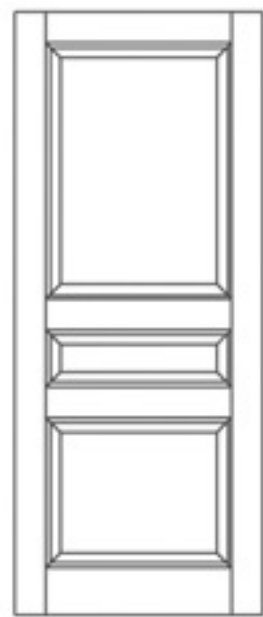

SD-FV12

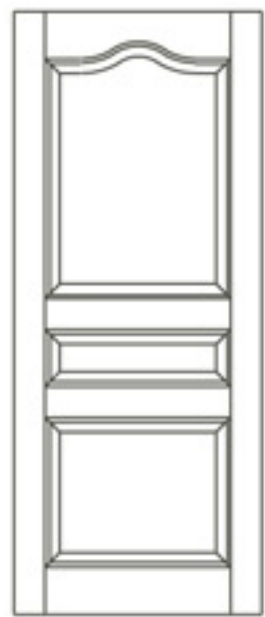

SD-FV13

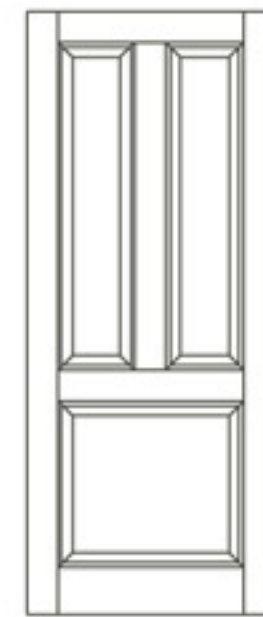

SD-FV14



SD-FV15

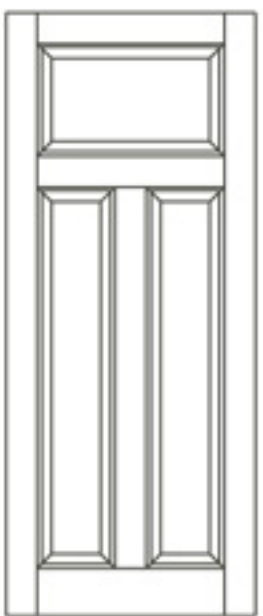

SD-FV16

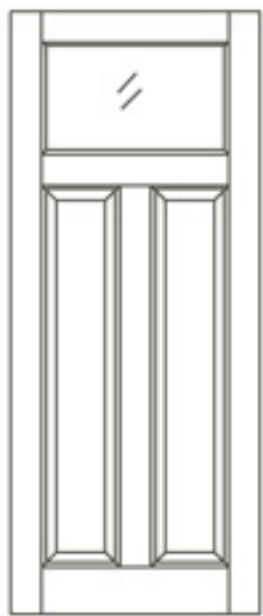

SD-FV17

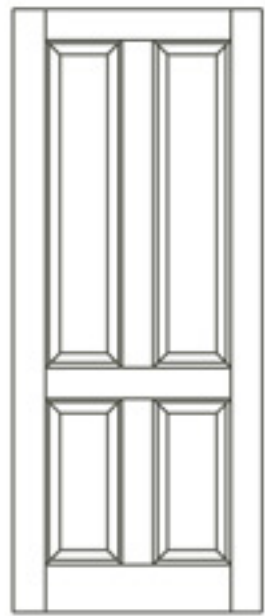

SD-FV18

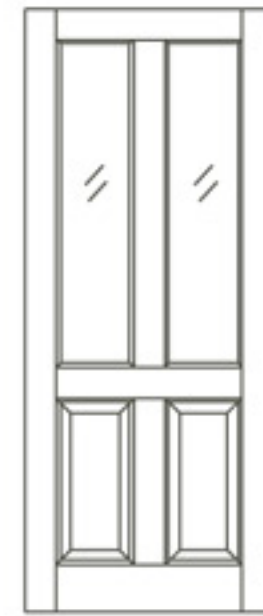

SD-FV19



SD-FV20

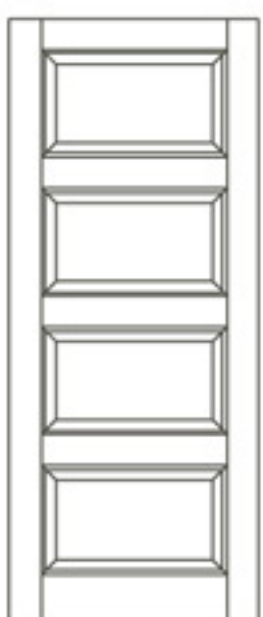

SD-FV21

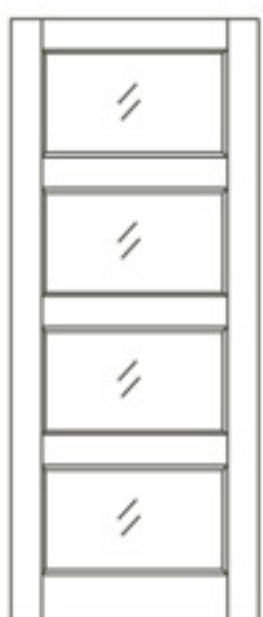

SD-FV22

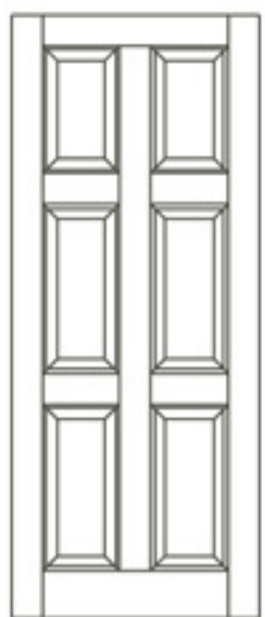

SD-FV23

# NOVA FLUSH (NF)

NOVA VEVEERED (NFV)

NOVA VEVEER PLAIN (NFV-P)

## Core:

- Inner frame: softwood/ LVL/ MDF (density = 780kg/cbm)
- Filling: honeycomb
- Structure: standard/ t° and humid resistant

## Faces:

- Base: 5-8mm MDF (density = 780kg/cbm)
- Veneer: 0,3-0,6mm quarter cut veneer
- Match: book match/ slip match/ miss match
- Edge: 0,6mm edge banding veneer

## Wood selection:

- Wood species:
  - ▶ Genuine veneers: white & red oak, teak, sappily, okoumé, black walnut, cherry, pine
  - ▶ Engineered veneers
- Grading: A-grade selected veneers
- Color: uniform color within 1 pallet (25-28 doors)

## Dimensions:

- ▶ Height: 1800-2400mm
- ▶ Width: 600-1200mm
- ▶ Thickness: 32-45mm

## Models:

- Vertical (NFV-P01)
- Horizontal (NFV-P02)

## ADDED VALUES:

### Pre-drilling:

- Lock, handle, hinges (left-right, reversible)

### Finishing:

- Oil, wax oil
- PU lacquer:
  - ▶ open grain/ closed grain
  - ▶ matt/ high gloss
  - ▶ stained

[Selected high quality finishing possible through our Belgian production site]

### Packing:

- Retail packing/ warehouse packing
- Labeling, branding (OEM), bar coding

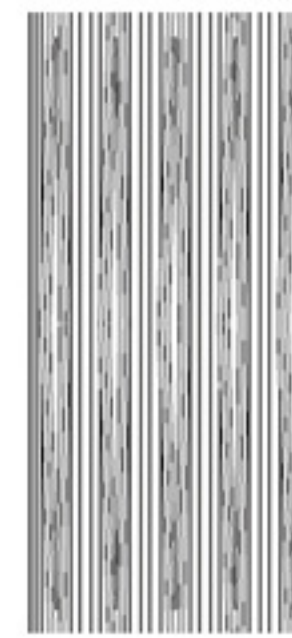
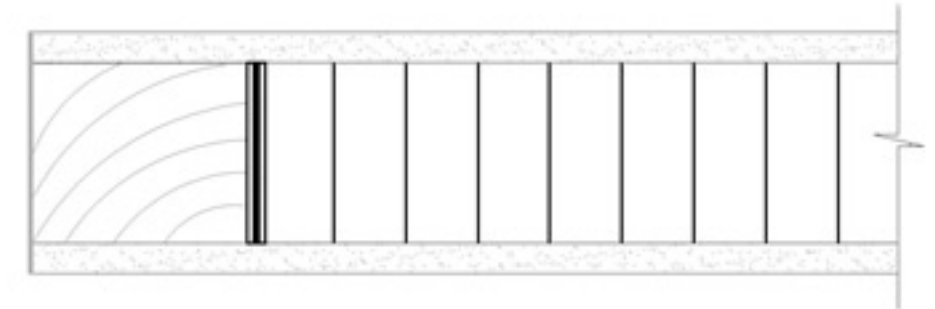

NFV-P01

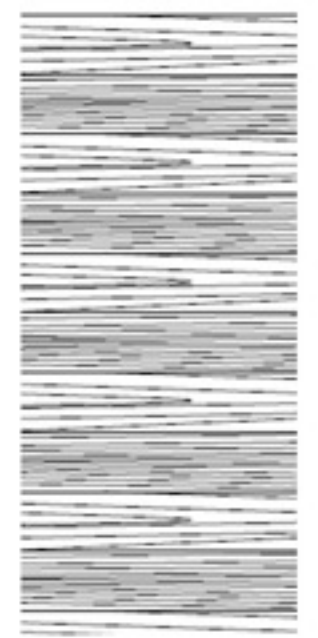

NFV-P02

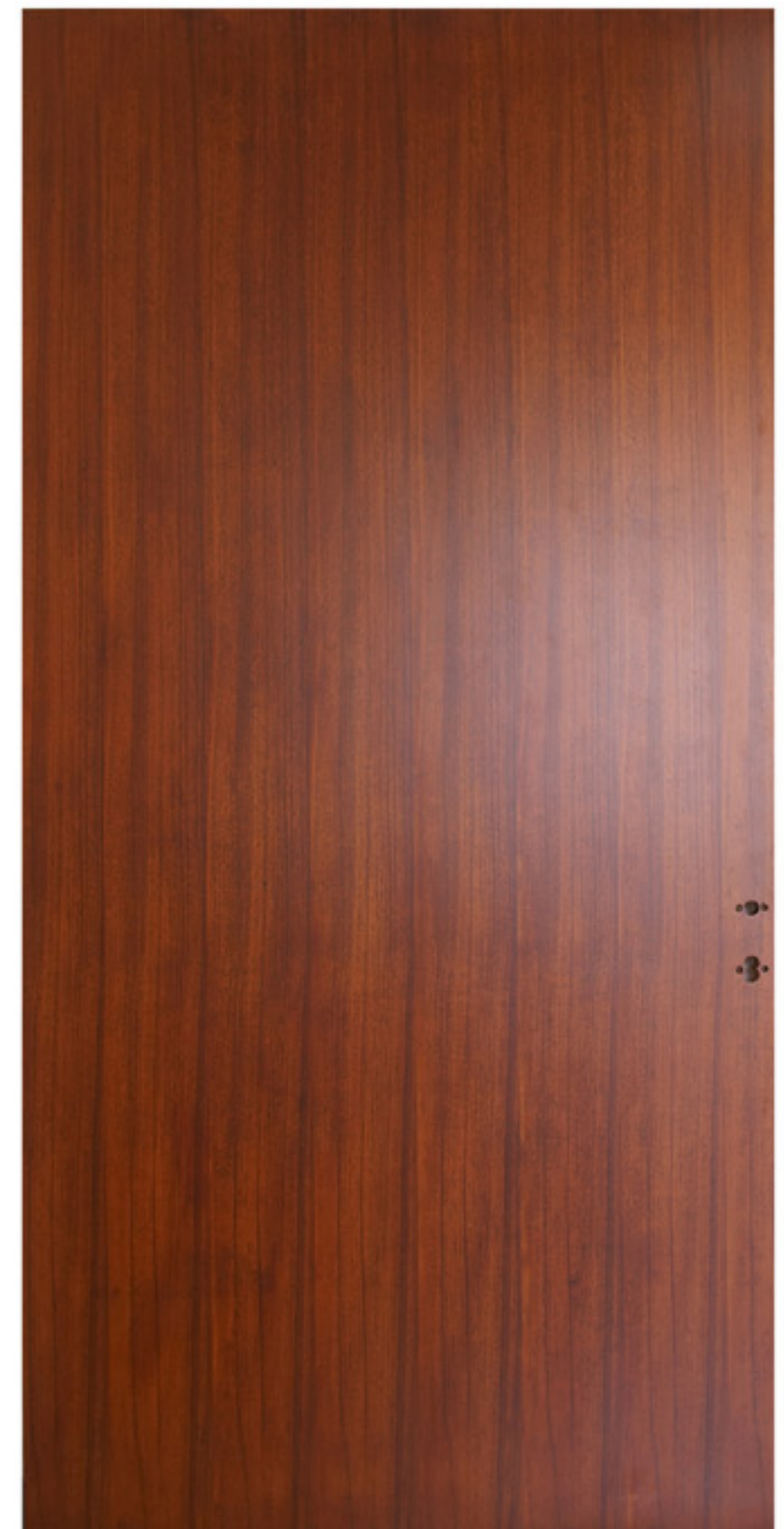

# NOVA FLUSH (NF)

NOVA VENEERED (NFV)

NOVA VENEER GROOVE (NFV-G)

## Core:

- Inner frame: softwood/ LVL/ MDF (density = 780kg/cbm)
- Filling: honeycomb
- Structure: standard/ t° and humid resistant

## Faces:

- Base: 5-8mm MDF (density = 780kg/cbm)
- Veneer: 0,3-0,6mm quarter cut veneer
- Match: book match/ slip match/ miss match
- Edge: 0,6mm edge banding veneer

## Wood selection:

- Wood species:
  - ▶ Genuine veneers: white & red oak, teak, sappily, okoume, black walnut, cherry, pine
  - ▶ Engineered veneers
- Grading: A-grade selected veneers
- Combination: different wood species possible
- Color: uniform color within 1 pallet (25-28 doors)

## Grooves:

- Structure: MDF grooved without veneer/ solid wood grooved
- Design: U/ V
- Dimensions: 2,5mm (d) x 7mm (w)
- Direction: straight with the direction of the veneer

## Dimensions:

- ▶ Height: 1800-2400mm
- ▶ Width: 600-1200mm
- ▶ Thickness: 32-45mm

## ADDED VALUES:

### Pre-drilling:

- Lock, handle, hinges (left-right, reversible)

### Finishing:

- Oil, wax oil
- PU lacquer:
  - ▶ open grain/ closed grain
  - ▶ matt/ high gloss
  - ▶ stained

[Selected high quality finishing possible through our Belgian production site]

### Packing:

- Retail packing/ warehouse packing
- Labeling, branding (OEM), bar coding

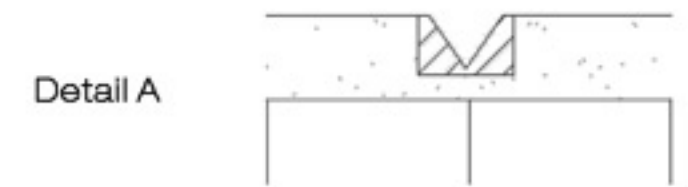
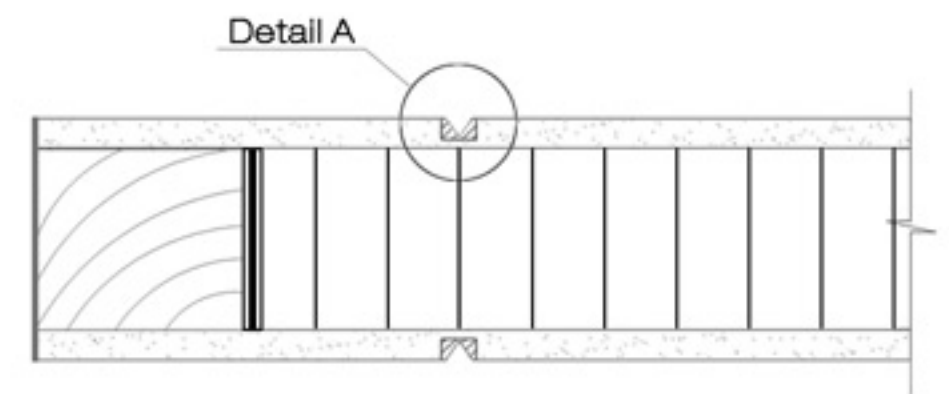

## Models:

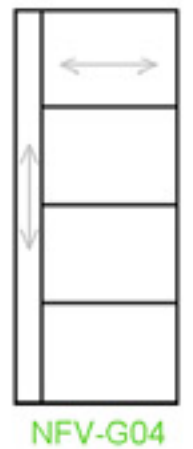
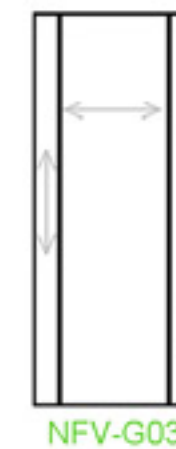
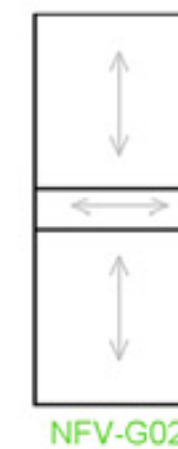
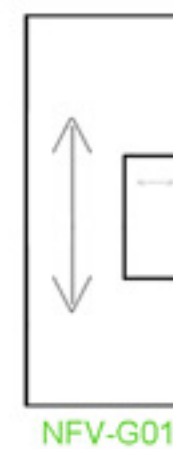

NFV-G03



NFV-G07

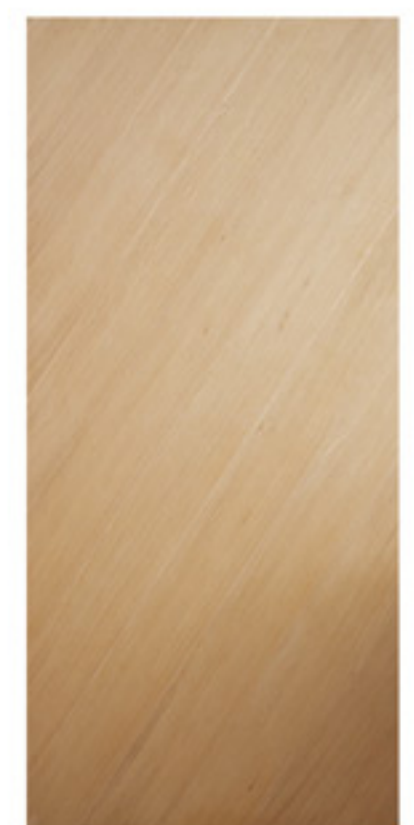

NFV-G08

# NOVA FLUSH (NF)

NOVA COLOR (NFC)

NOVA COLOR PLAIN (NFC-P)

## Core:

- Inner frame: softwood/ LVL/ MDF (density = 780kg/cbm)
- Filling: honeycomb
- Structure: standard/ t° and humid resistant

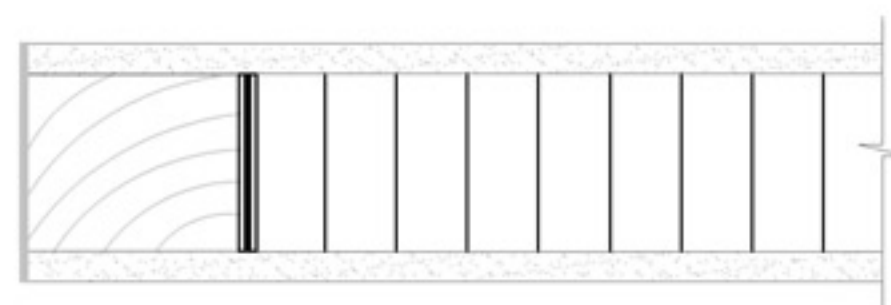

## Faces:

- Base: 5-8mm MDF (density = 780kg/cbm)
- Edge: 0,6mm edge banding veneer



## Finishing:

- Prime: general/ professional
- Lacquering: PU/ water based
- Gloss: high/ matt
- Colors: any RAL code



## Dimensions:

- ▶ Height: 1800-2400mm
- ▶ Width: 600-1200mm
- ▶ Thickness: 32-45mm

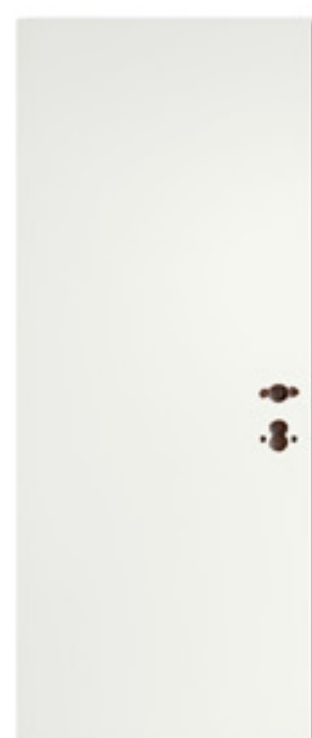

Dutch white  
RAL 9010



Grey beige  
RAL 1019

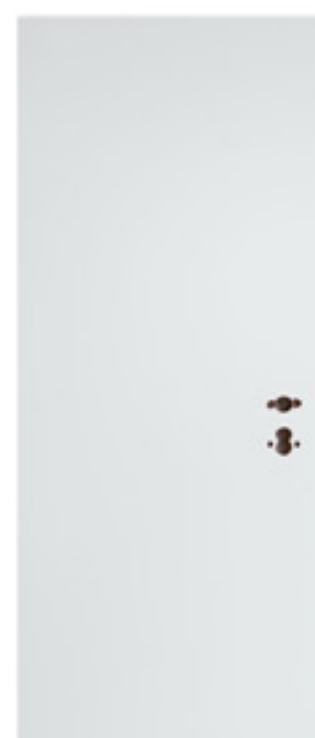

Traffic white  
RAL 9016



Platinum grey  
RAL 7036



Tele grey  
RAL 7047



Brown grey  
RAL 7013

## ADDED VALUES:

### Pre-drilling:

- Lock, handle, hinges (left-right, reversible)

### Packing:

- Retail packing/ warehouse packing
- Labeling, branding (OEM), bar coding



# NOVA FLUSH (NF)

NOVA COLOR (NFC)

NOVA COLOR GROOVE (NFC-G)

## Core:

- Inner frame: softwood/ LVL/ MDF (density = 780 kg/cbm)
- Filling: honeycomb
- Structure: standard/ t° and humid resistant

## Faces:

- Base: 5-8mm MDF (density = 780 kg/cbm)
- Prime: suitable for all color finishing

## Grooves:

- Structure: MDF grooved with(out) lacquer
- Design: any design possible
- Dimensions: 2,5mm (d) x 7mm (w)
- Direction: straight and/or curved

## Finishing:

- Prime: general/ professional
- Lacquering: PU/ water based
- Gloss: high/ matt
- Color: any RAL code

## Dimensions:

- ▶ Height: 1800-2400mm
- ▶ Width: 600-1200mm
- ▶ Thickness: 32-45mm

## Models:

see overview on a separate page

## ADDED VALUES:

### Pre-drilling:

- Lock, handle, hinges (left-right, reversible)

### Packing:

- Retail packing/ warehouse packing
- Labeling, branding (OEM), bar coding

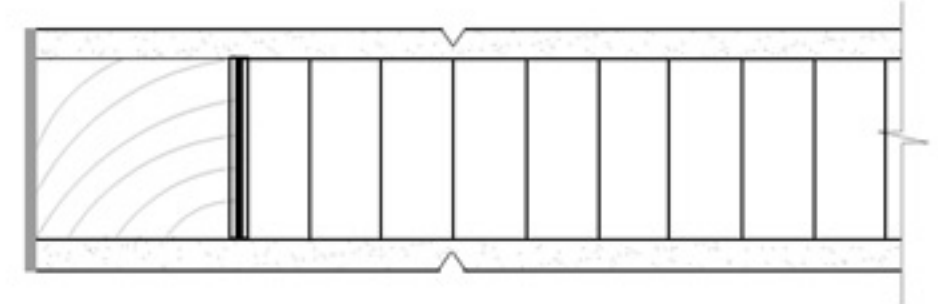

# NOVA FLUSH (NF)

NOVA COLOR (NFC)

NOVA COLOR GROOVE (NFC-G) - MODELS

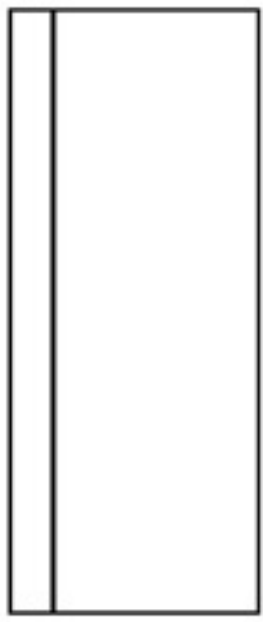

NFC-G01

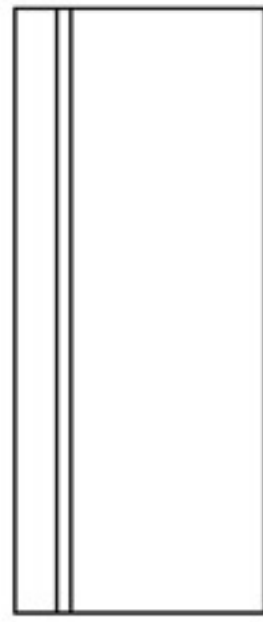

NFC-G02

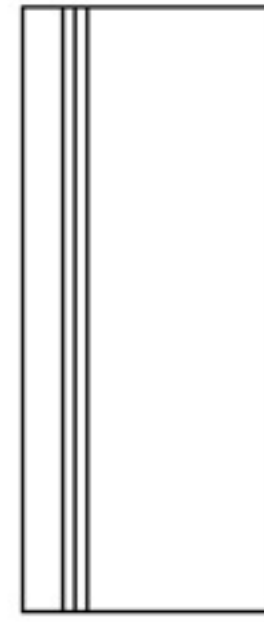

NFC-G03

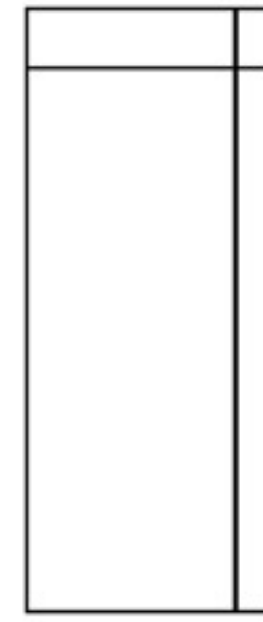

NFC-G04

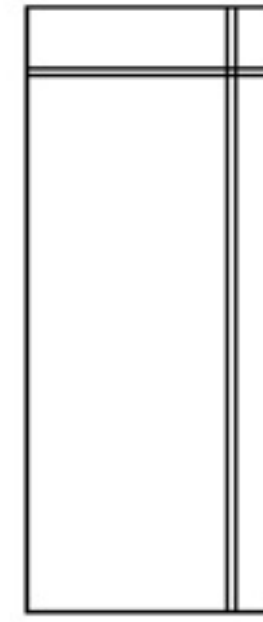

NFC-G05

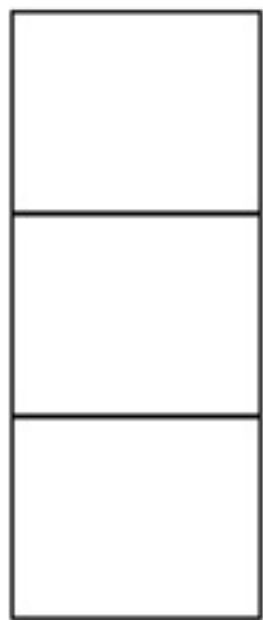

NFC-G06

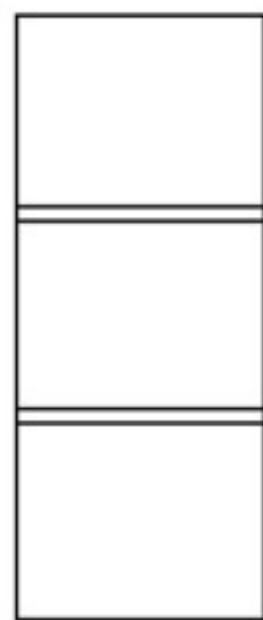

NFC-G07



NFC-G08



NFC-G09



NFC-G10

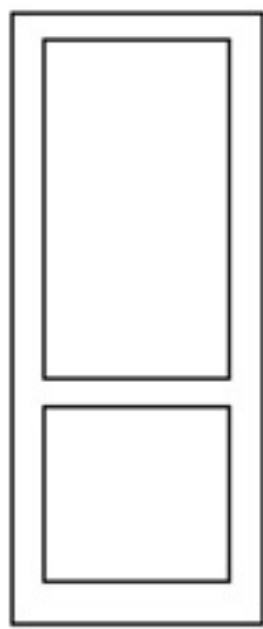

NFC-G11

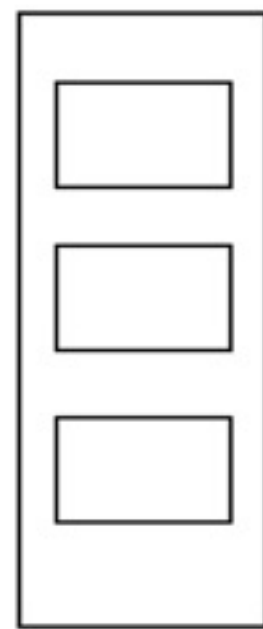

NFC-G12

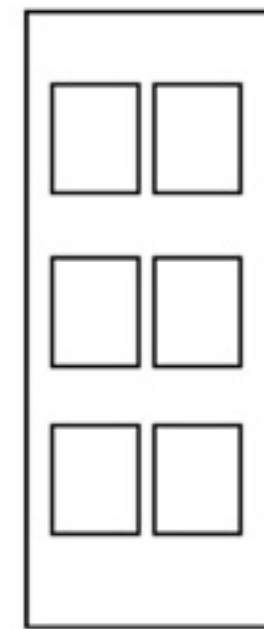

NFC-G13

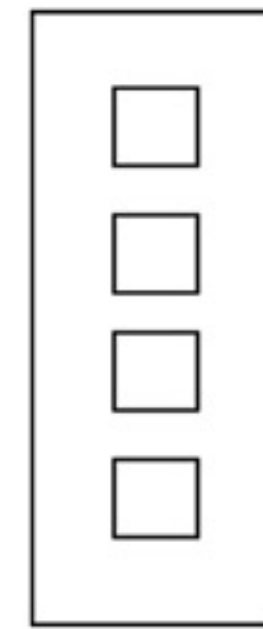

NFC-G14

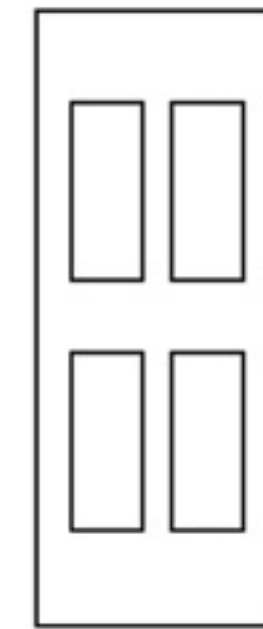

NFC-G15

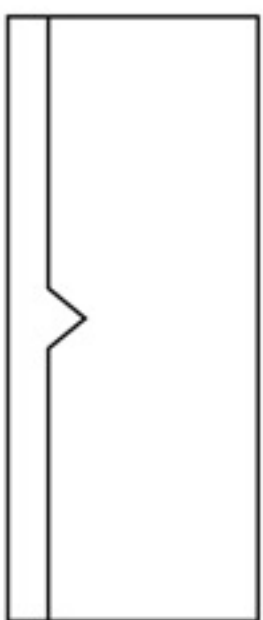

NFC-G16

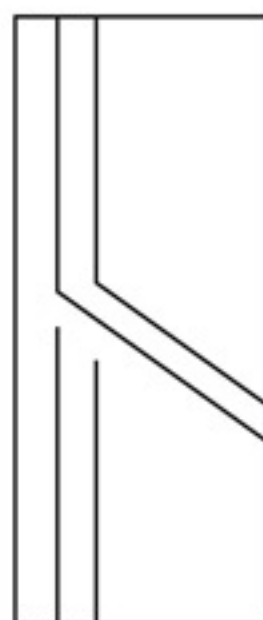

NFC-G17

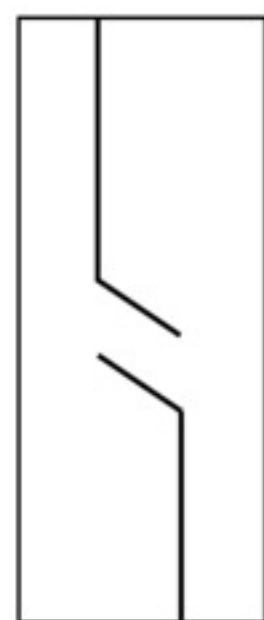

NFC-G18

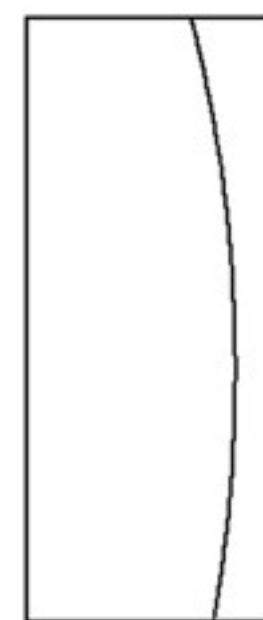

NFC-G19

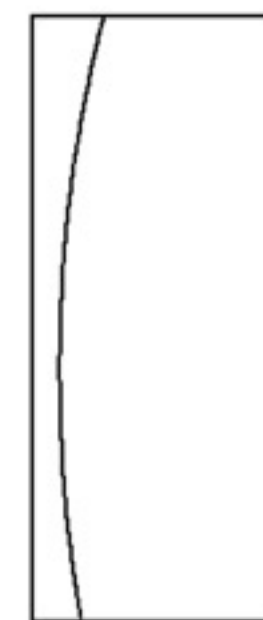

NFC-G20

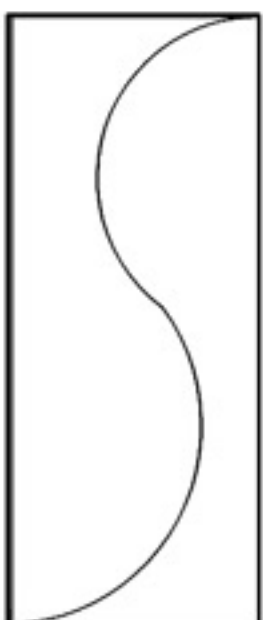

NFC-G21

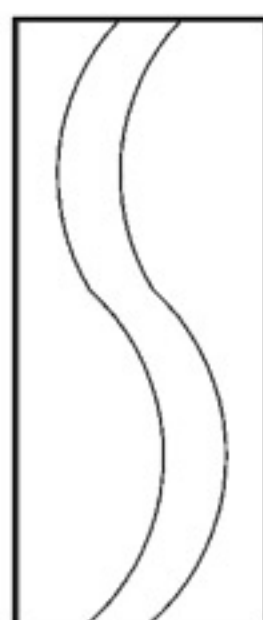

NFC-G22



NFC-G23

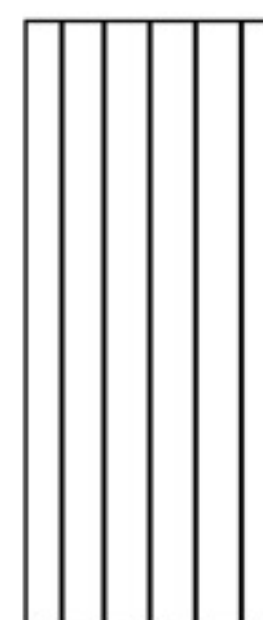

NFC-G24



NFC-G25

# PRESS PLUS (PP)



## PRESS PLUS VENEERED (PP-V)

### Core:

- Inner frame: softwood/ LVL/ MDF (density = 780kg/cbm)
- Filling: honeycomb
- Structure: standard/ t° and humid resistant

### Faces:

- Base: 3mm HDF (density = 900kg/cbm)
- Veneer: 0,18mm veneer
- Match: slip match
- Edge: 0,6mm edge banding veneer

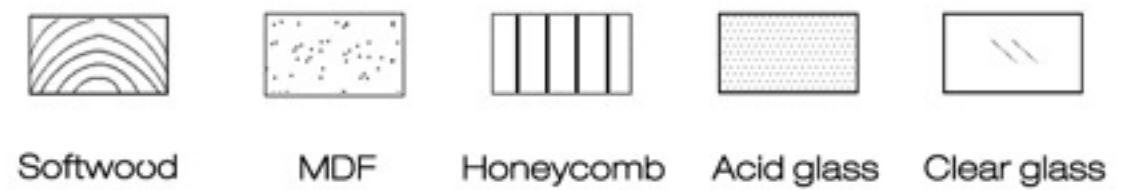
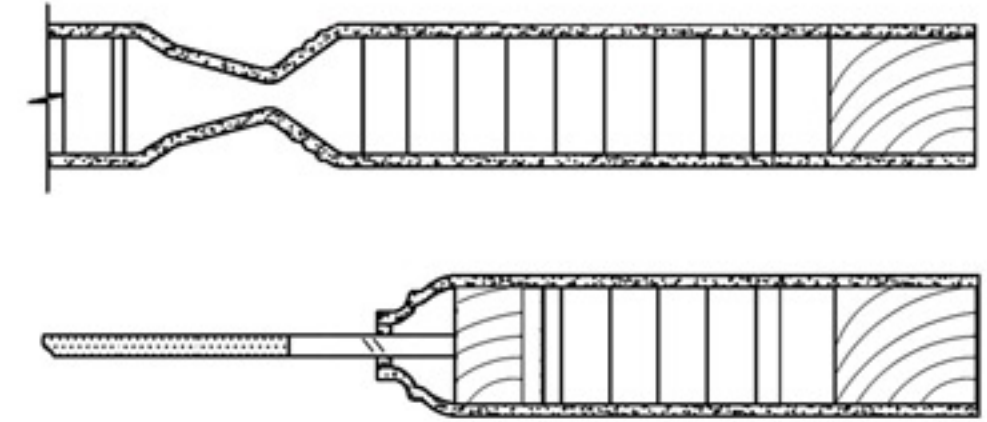

### Wood selection:

- Wood species:
  - ▶ Genuine veneers: white & red oak, teak, sappily, ash, cherry, pine
  - ▶ Engineered veneers
- Grading: A-grade selected veneers
- Color: some color variation allowed

### Dimensions:

- ▶ Height: 1980-2150mm
- ▶ Width: 670-1030mm
- ▶ Thickness: 32-45mm

### Models:

see overview on a separate page

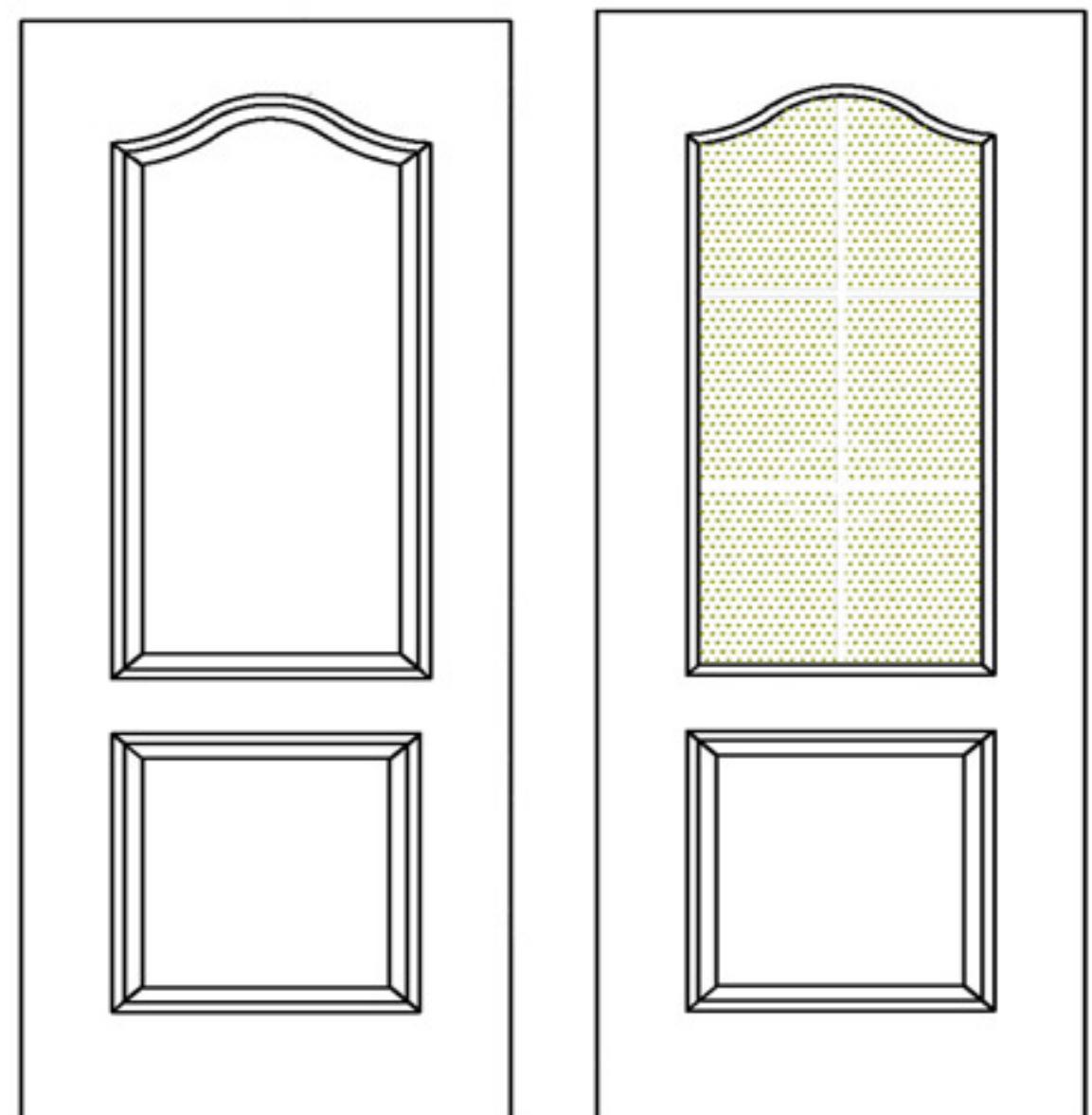

### ADDED VALUES:

#### Pre-drilling:

- Lock, handle, hinges (left-right, reversible)

#### Finishing:

- Primed
- PU lacquer:
  - ▶ closed grain
  - ▶ matt
  - ▶ stained

#### Packing:

- Retail packing/ warehouse packing
- Labeling, branding (OEM), bar coding



# PRESS PLUS (PP)



## PRESS PLUS COLORED (PP-C)

### Core:

- Inner frame: softwood/ LVL/ MDF (density = 780kg/cbm)
- Filling: honeycomb
- Structure: standard/ t° and humid resistant

### Faces:

- Base: 3mm HDF (density = 900kg/cbm)
- Skin: smooth/ wood grain design

### Finishing:

- Prime: general
- Lacquer: PU/ water based
- Color: any RAL code

### Dimensions:

- ▶ Height: 1980-2150mm
- ▶ Width: 670-1030mm
- ▶ Thickness: 32-45mm

### Models:

see overview on a separate page

### ADDED VALUES:

#### Pre-drilling:

- Lock, handle, hinges (left-right, reversible)

#### Finishing:

- Primed
- PU lacquer: ▶ closed grain
  - ▶ matt
  - ▶ stained

#### Packing:

- Retail packing/ warehouse packing
- Labeling, branding (OEM), bar coding

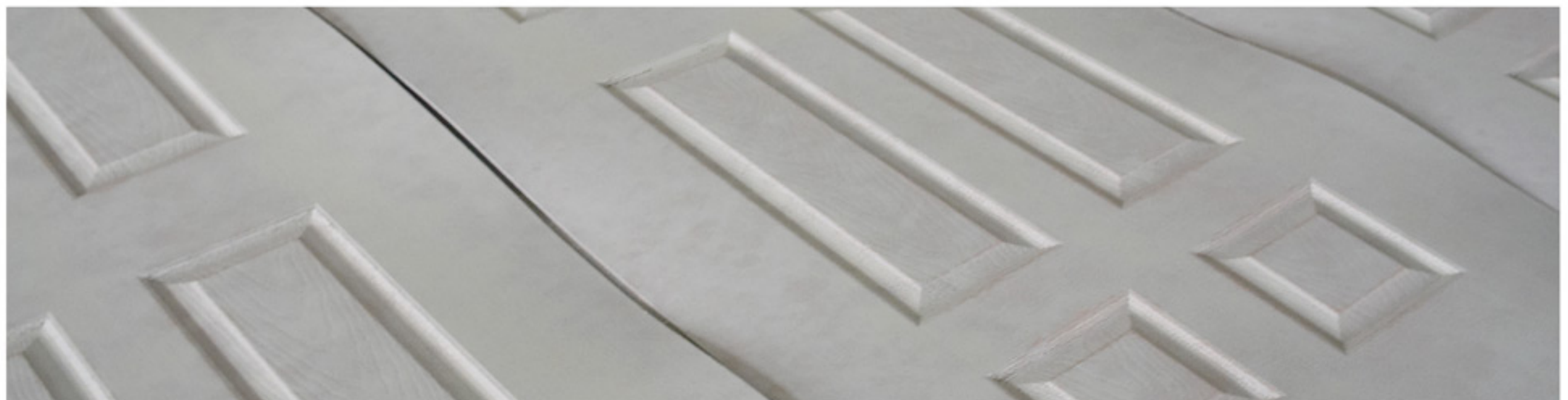
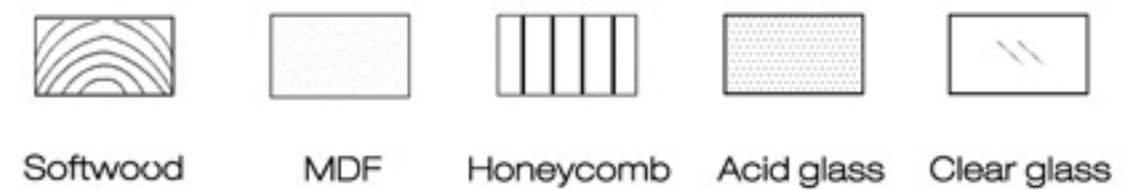
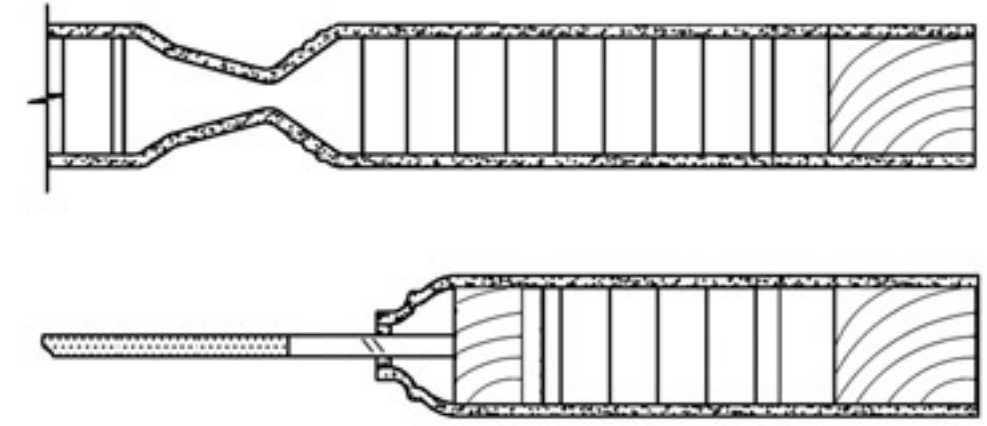

# PRESS PLUS (PP)

VENEERED (PP-V) & WHITE SMOOTH (PP-C) - MODELS



PP-01



PP-02



PP-03



PP-04



PP-05



PP-06



PP-07



PP-08



PP-09



PP-10



PP-11



PP-12



PP-13

## WHITE WITH WOOD GRAIN (PP-C) - MODELS



PP-14

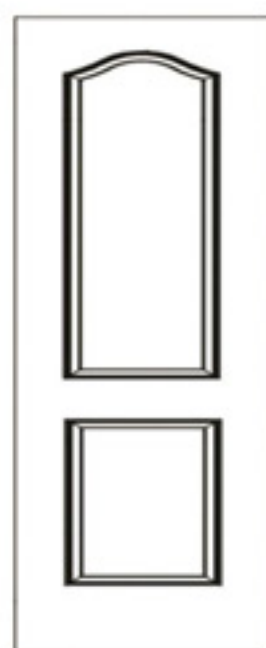

PP-15

# CONCEPT DOOR (CD)



## SHAKER LIGHT (CD-SL) SHAKER LIGHT VENEERED (CD-SLV)

Concept: Modern, solid looking shaker door at a better price than a full stile door and produced in a more environmental friendly way.

### Core:

- Inner frame: softwood/ LVL/ MDF (density = 780kg/cbm)
- Filling: honeycomb
- Structure: standard/ t° and humid resistant

### Faces:

- Base: 5-8mm MDF (density = 780kg/cbm)
- Veneer: 0,3-0,6mm quarter cut veneer
- Match: book match/ slip match/ miss match
- Edge: 0,6mm edge banding veneer

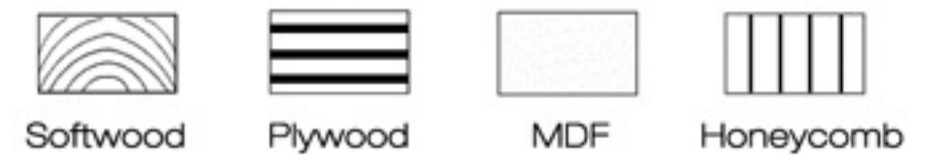
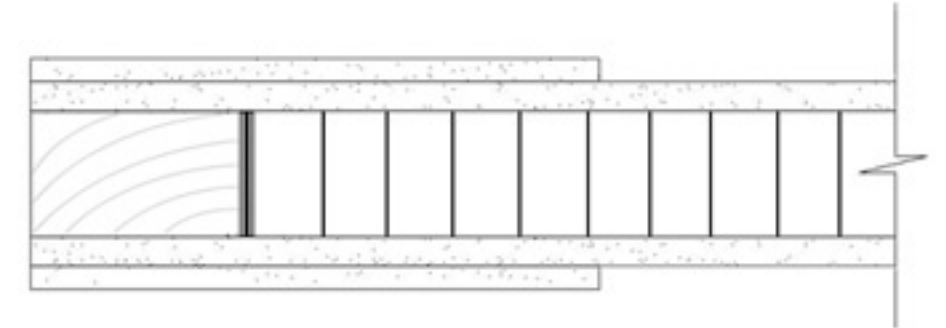

### Wood selection:

- Wood species:
  - ▶ Genuine veneers: white & red oak, teak, sappily, okoume, black walnut, cherry
  - ▶ Engineered veneers
- Grading: A-grade selected veneers
- Color: uniform color within 1 pallet (25-28 doors)

### Dimensions:

- ▶ Height: 1800-2400mm
- ▶ Width: 600-1200mm
- ▶ Thickness: 32-45mm



CD-SLV04



CD-SLV07

### Models:

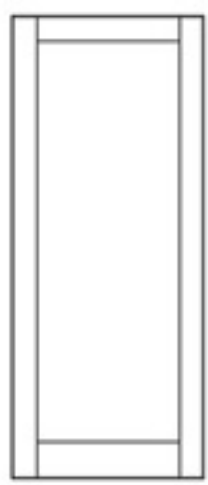

CD-SLV01

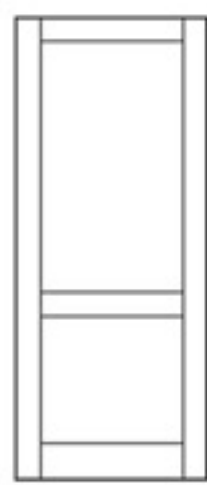

CD-SLV02

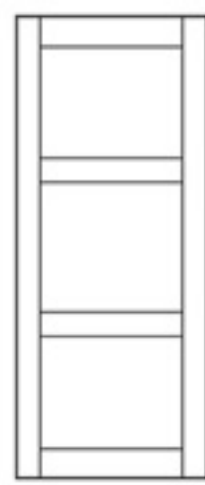

CD-SLV03

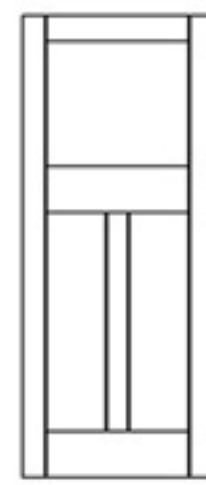

CD-SLV04

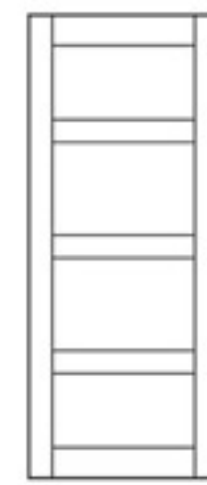

CD-SLV05

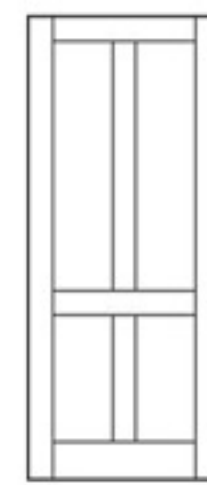

CD-SLV06

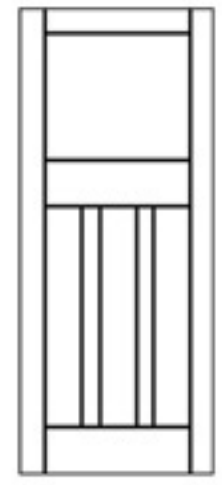

CD-SLV07

### ADDED VALUES:

#### Pre-drilling:

- Lock, handle, hinges (left-right, reversible)

#### Finishing:

- Oil, wax oil
- PU lacquer:
  - ▶ open grain/ closed grain
  - ▶ matt/ high gloss
  - ▶ stained

[Selected high quality finishing possible through our Belgian production site]

#### Packing:

- Retail packing/ warehouse packing
- Labeling, branding (OEM), bar coding



# CONCEPT DOOR (CD)



## SHAKER LIGHT (CD-SL) SHAKER LIGHT COLOR (CD-SLC)

Concept: Modern, solid looking shaker door at a better price than a full stile door and produced in a more environmental friendly way

### Core:

- Inner frame: softwood/ LVL/ MDF (density =780kg/cbm)
- Filling: honeycomb
- Structure: standard/ t° and humid resistant

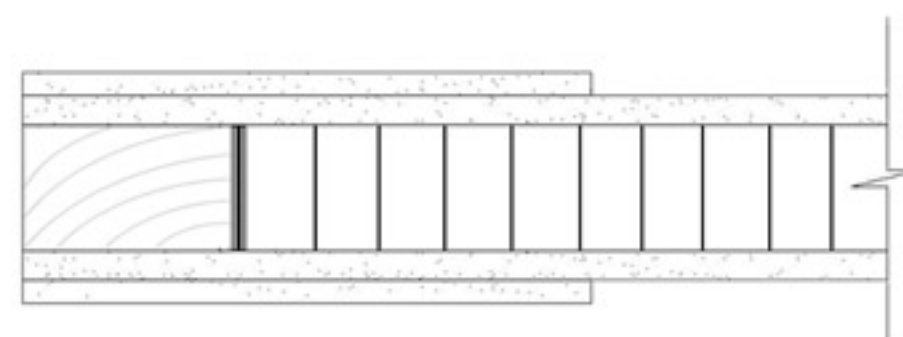

### Faces:

- Base: 5-8mm MDF (density =780kg/cbm)
- Edge: 0,6mm edge banding veneer



### Finishing:

- Prime: general/ professional
- Lacquering: PU/ waterbased
- Gloss: high/ matt
- Color: any RAL code



### Dimensions:

- ▶ Height: 1800-2400mm
- ▶ Width: 600-1200mm
- ▶ Thickness: 32-45mm

### Models:



CD-SLC01

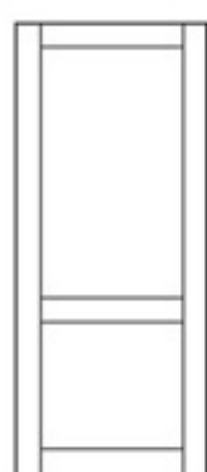

CD-SLC02

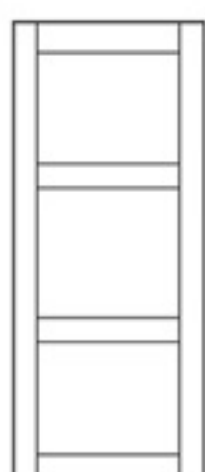

CD-SLC03

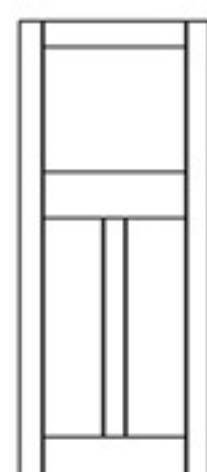

CD-SLC04

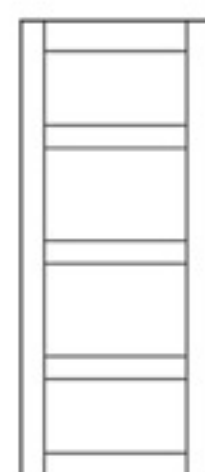

CD-SLC05

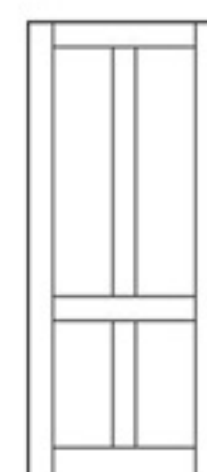

CD-SLC06

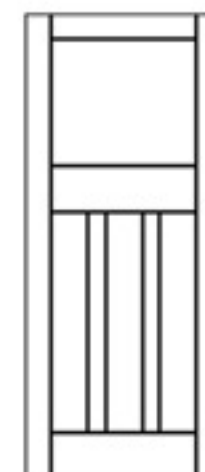

CD-SLC07

### ADDED VALUES:

#### Pre-drilling:

- Lock, handle, hinges (left-right, reversible)

#### Packing:

- Retail packing/ warehouse packing
- Labeling, branding (OEM), bar coding



# CONCEPT DOOR (CD)

## RETREE – THIERRY DOOR (CD-RT)

Concept: In harmony with ReTree wooden floors...

### Core:

- Inner frame: softwood/ LVL/ MDF (density = 780kg/cbm)
- Filling: honeycomb
- Structure: standard/ t° and humid resistant

### Faces:

- Base: 5-8mm MDF (density =780kg/cbm)
- Veneer: 0,6mm veneer
- Match: miss match
- Edge: 0,6mm edge banding veneer

### Wood selection:

- Wood species: white oak
- Grading: primo selected veneers
- Combination: different wood species possible
- Color: uniform color within 1 pallet (25-28 doors)

### Dimensions:

- ▶ Height: 1800-2400mm
- ▶ Width: 600-1200mm
- ▶ Thickness: 32-45mm

### Models:

- Single
- Double

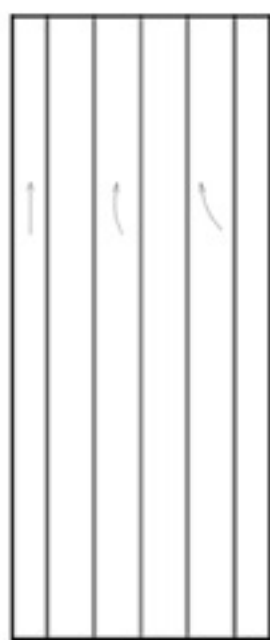

CD-RT01

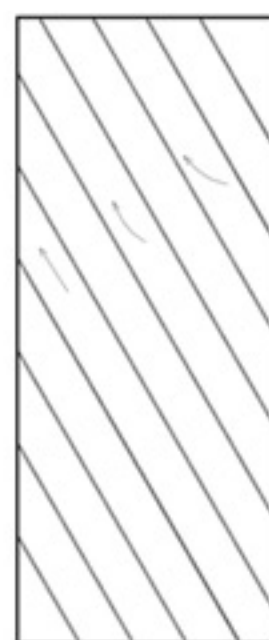

CD-RT02



CD-RT03

### ADDED VALUES:

#### Pre-drilling:

- Lock, handle, hinges (left-right, reversible)

#### Packing:

- Retail packing/ warehouse packing
- Labeling, branding (OEM), bar coding

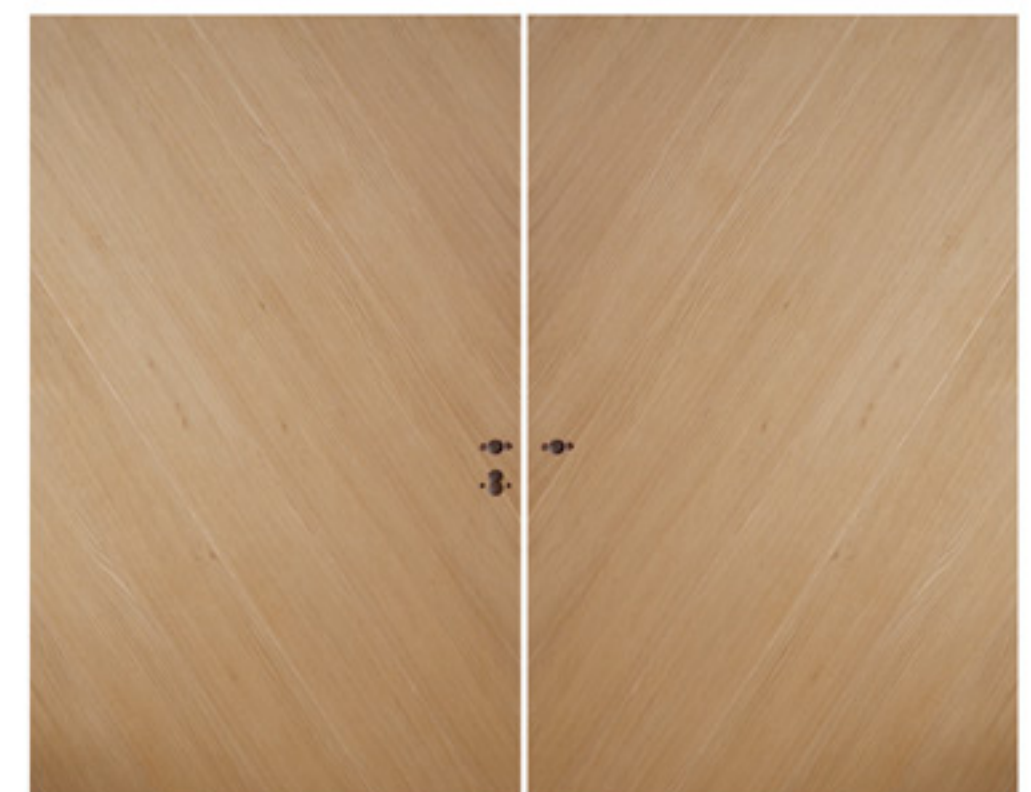
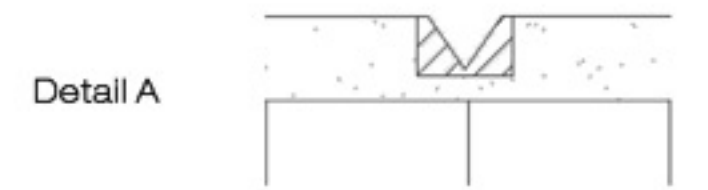
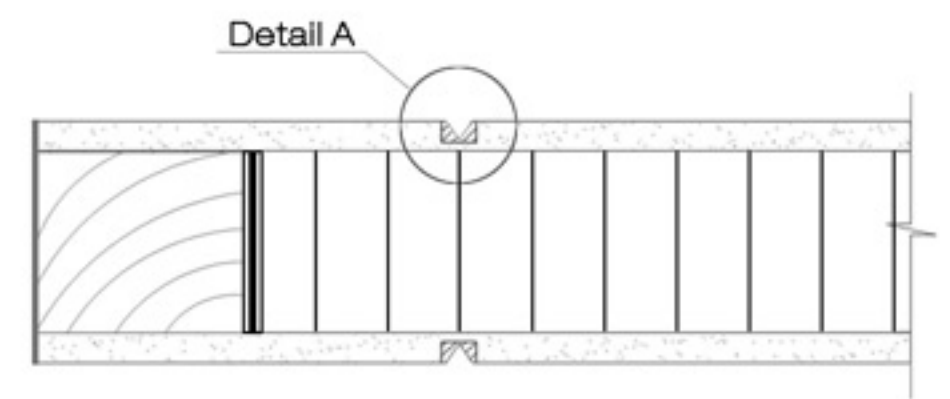

CD-RT02

CD-RT03

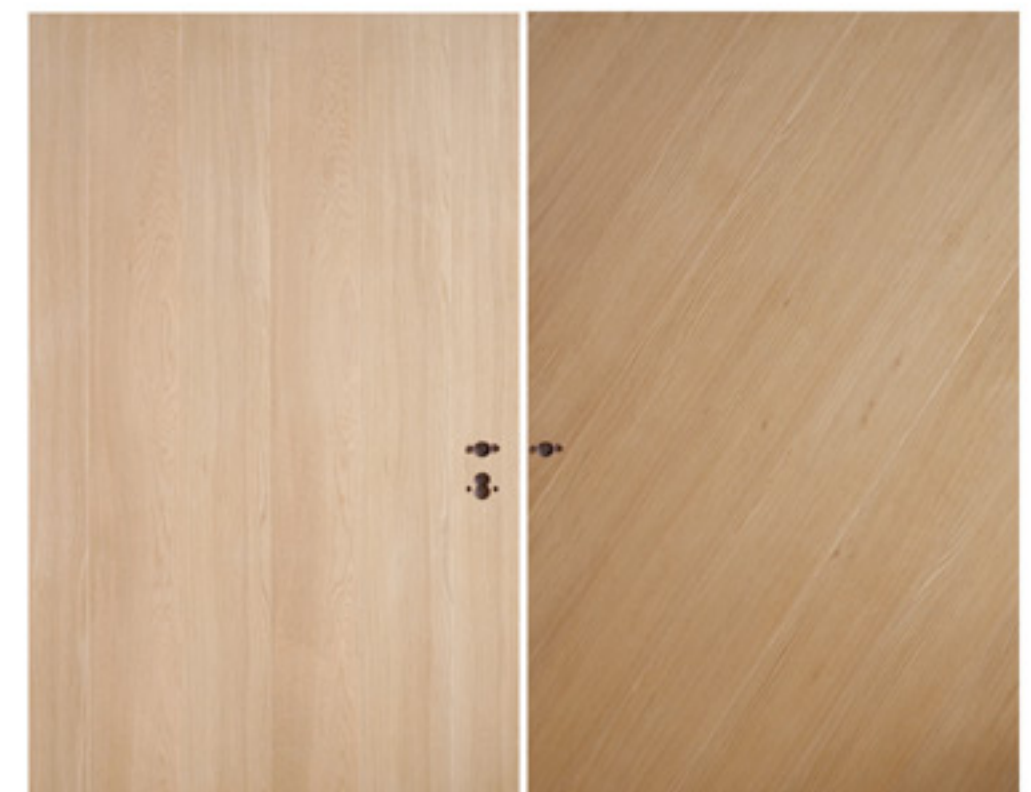

CD-RT01

CD-RT03

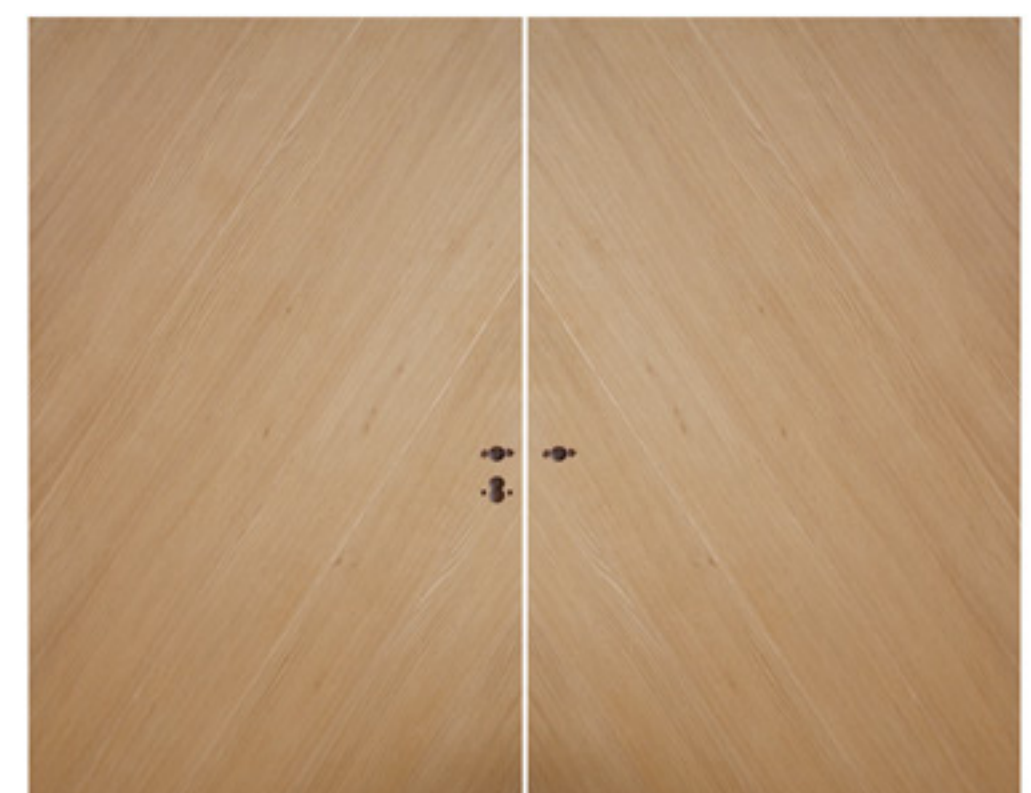

CD-RT03

CD-RT02

# CONCEPT DOOR (CD)

## WHITE TULIP (CD-WT)

Concept: Stable door with rich, embossed moldings and a high quality prime layer which provides a flexible finishing.

### Stile & Rails:

- Core: MDF (density = 780kg/cbm)
- Edge: white PVC edge bending
- Moulding: MDF (density = 780kg/cbm)

### Panels:

- Core: 18mm MDF (density = 780 kg/cbm)
- Glazed: possible
- Moulding: angled/ smooth

### Finishing:

- Prime: professional
- Lacquering: PU
- Color: White RAL 9010

### Dimensions:

- ▶ Height: 2015mm – 2115mm – 2315mm
- ▶ Width: 600-1200mm
- ▶ Thickness: 39mm

### Profiles:

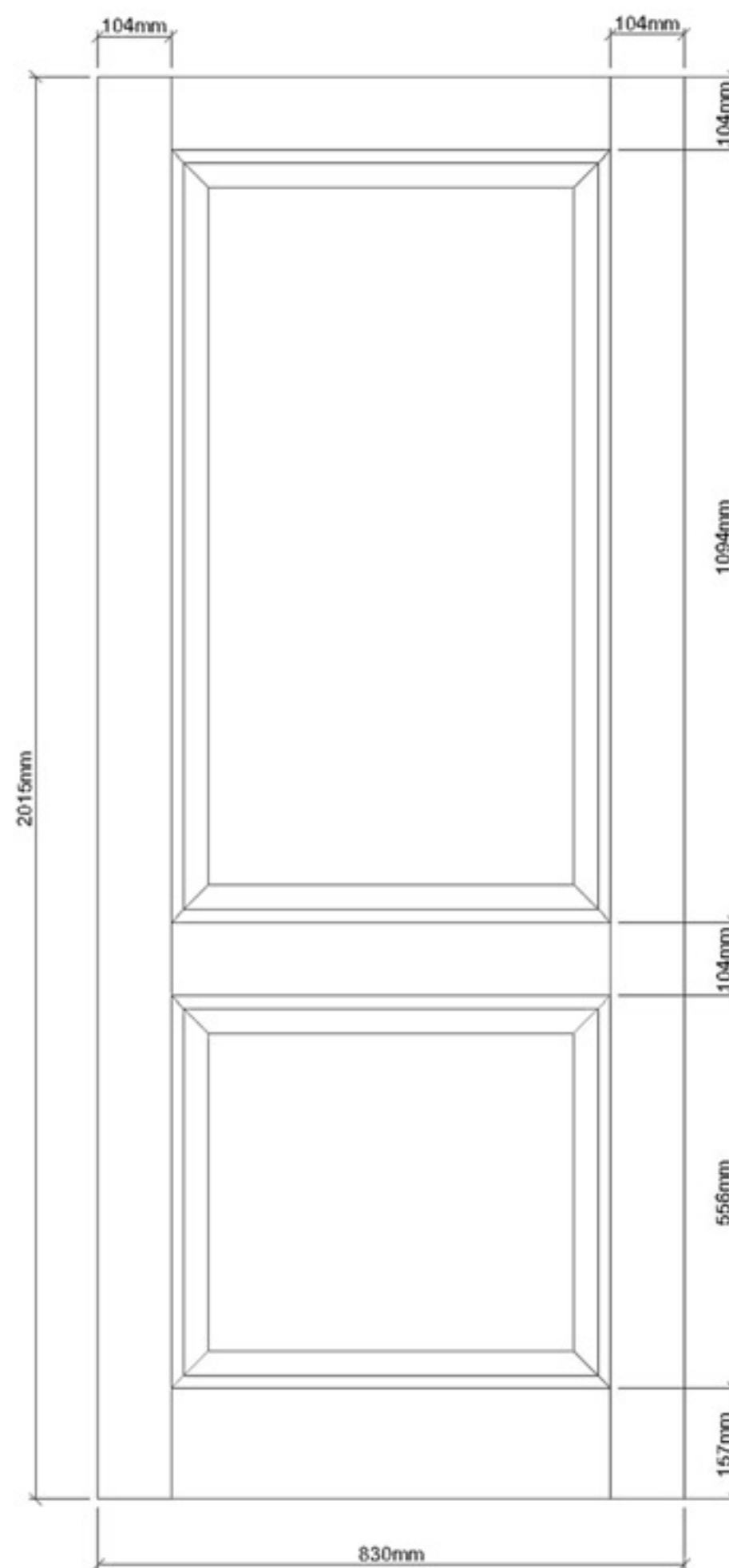
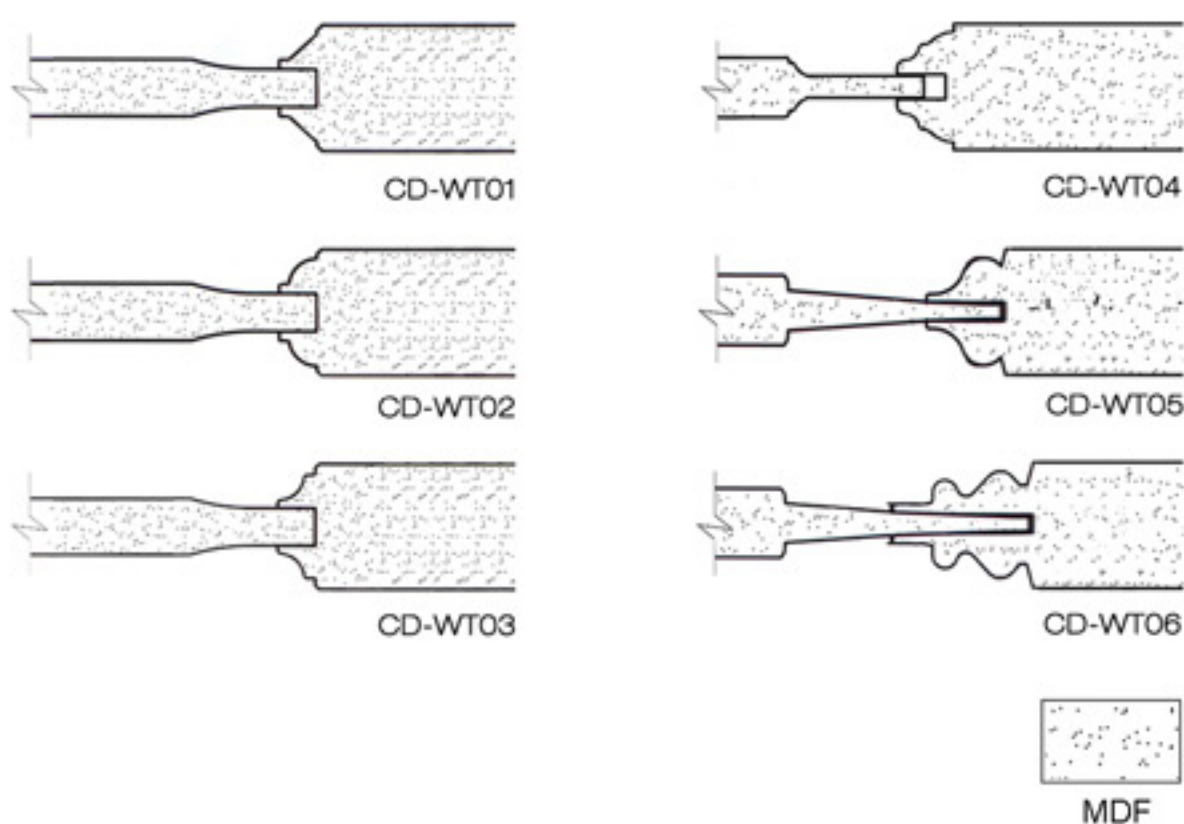

### ADDED VALUES:

#### Pre-drilling:

- Lock, handle, hinges (left-right, reversible)

#### Packing:

- Retail packing/ warehouse packing
- Labeling, branding (OEM), bar coding



# TRIM & FIX FRAME SYSTEM



## Components:

### 1. Jamb:

- ▶ 1x pre-drilled strike jamb
- ▶ 1x pre-drilled hinge jamb
- ▶ 1x pre-drilled upper jamb



Upper Jamb

### 2. Door stopper:

- ▶ 3x door stopper: - loose beat/ fixed beat
- with/ without sealing rubber

### 3. Architraves:

- ▶ 2x3 architraves

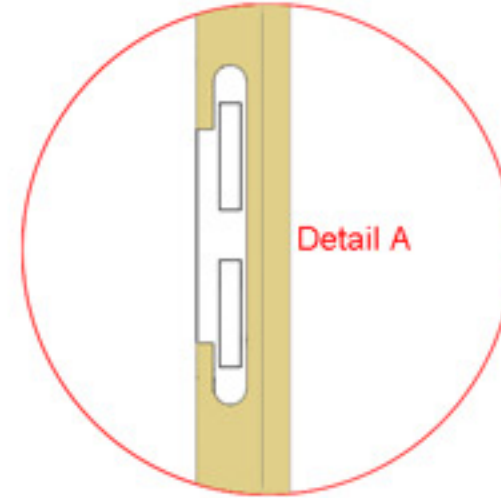

Detail A

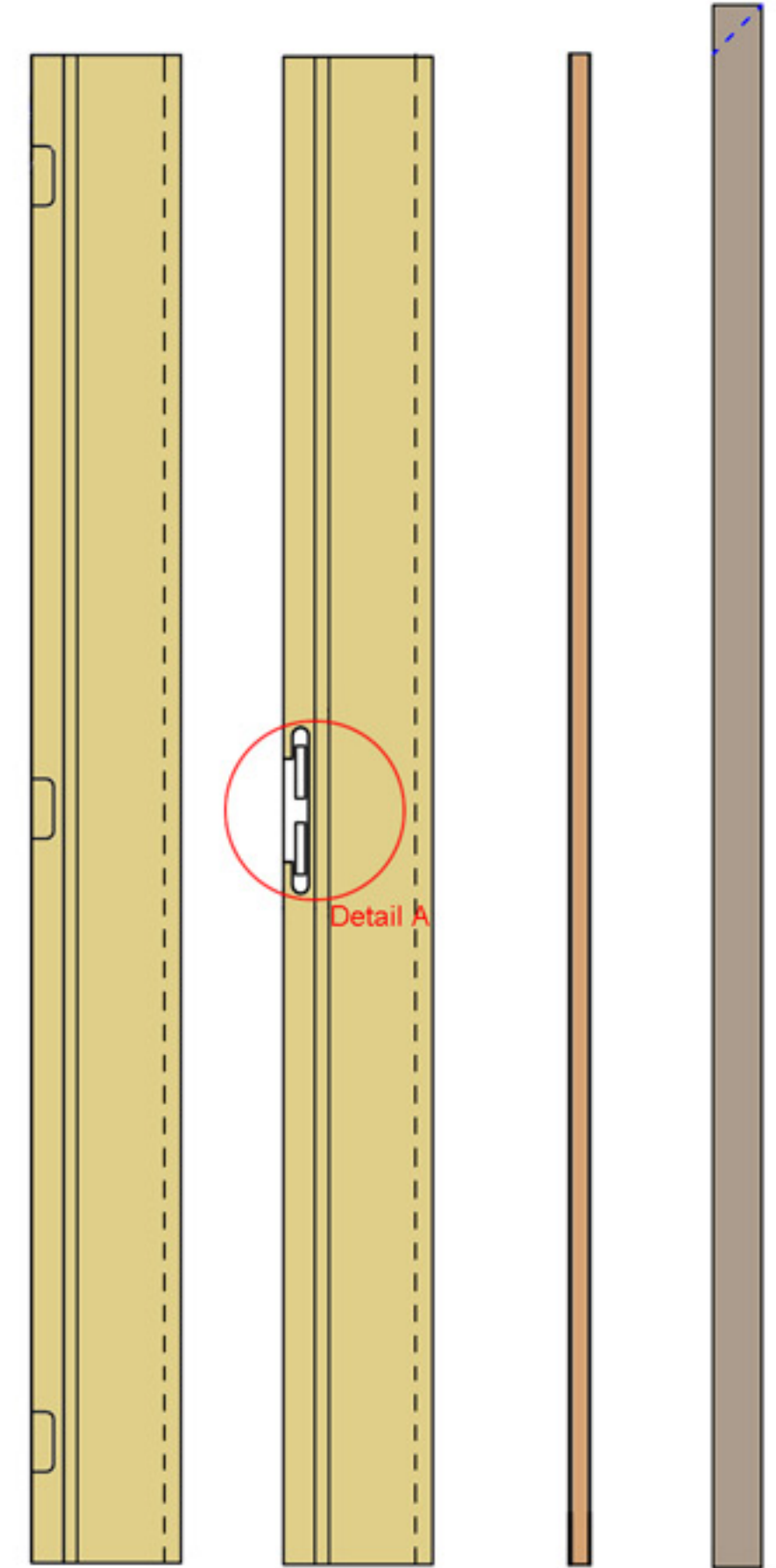

Hinge Jamb

Strike Jamb

Door Stopper

Architrave

## Specifications:

- Core: ▶ MDF: economic, 1x installation
- ▶ MDF+softwood: multiple hanging possible, moisture resistant
- Face: wood veneered/ primed/ lacquered or oiled
- Finishing: same as complementary door

## Dimensions:

- ▶ Height: max. 2400mm
- ▶ Width\*: 150mm/ 180mm/ 200mm
- ▶ Thickness: 18mm/ 25mm

\*Note: for projects with same wall thicknesses the frame width can be customized according to request

## Installation:

- ▶ Trimming: on site according to the actual wall thickness
- ▶ Flexible: towards projects with different wall thicknesses
- ▶ Reversible: same frame can be installed for right and left doors

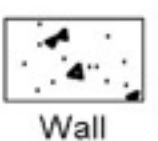
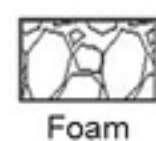
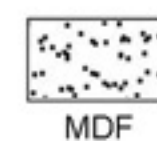
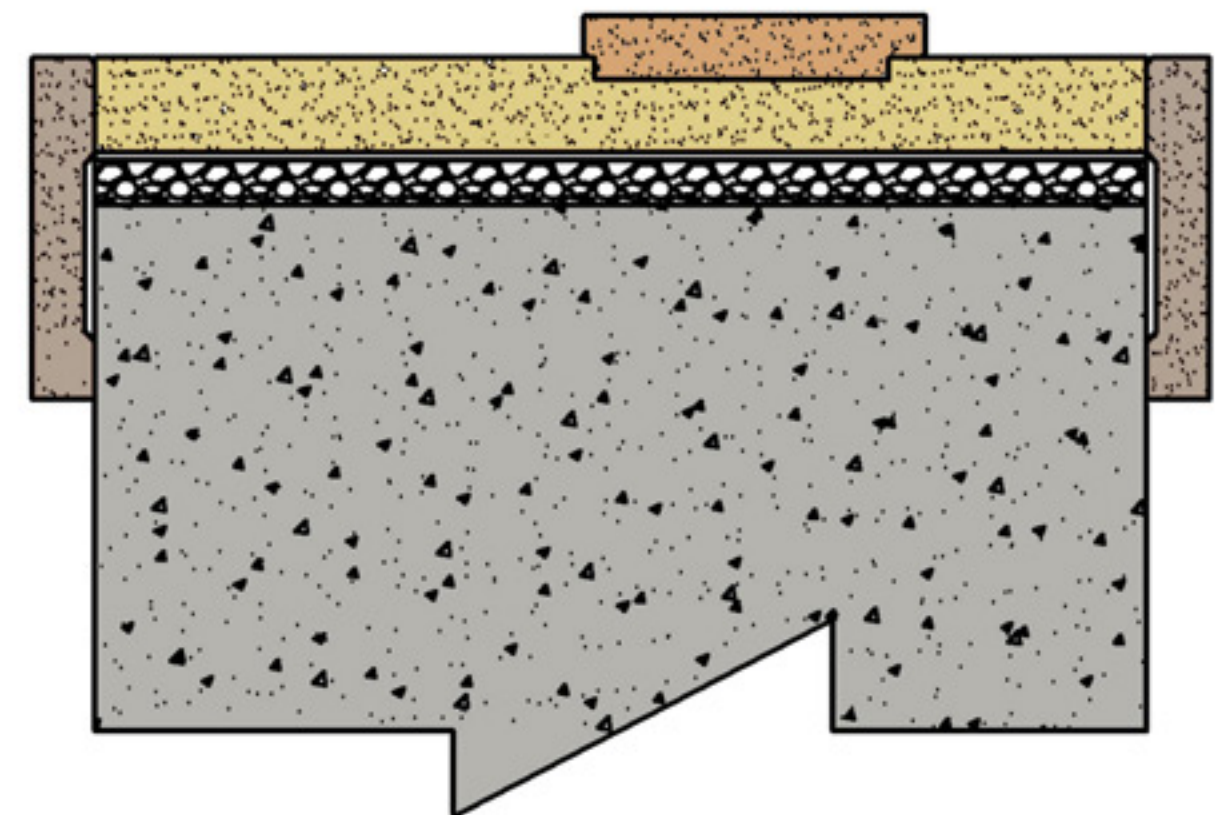

# ADJUSTABLE FRAME SYSTEM



## Components:

### 1. Jamb:

- ▶ 1x pre-drilled strike jamb
- ▶ 1x pre-drilled hinge jamb
- ▶ 1x pre-drilled upper jamb



Upper Jamb

### 2. Door stopper:

- ▶ 3x door stopper: - loose beat/ fixed beat  
- with/ without rubber

### 3. Architraves:

- ▶ 3x right adjustable architrave
- ▶ 3x left adjustable architrave

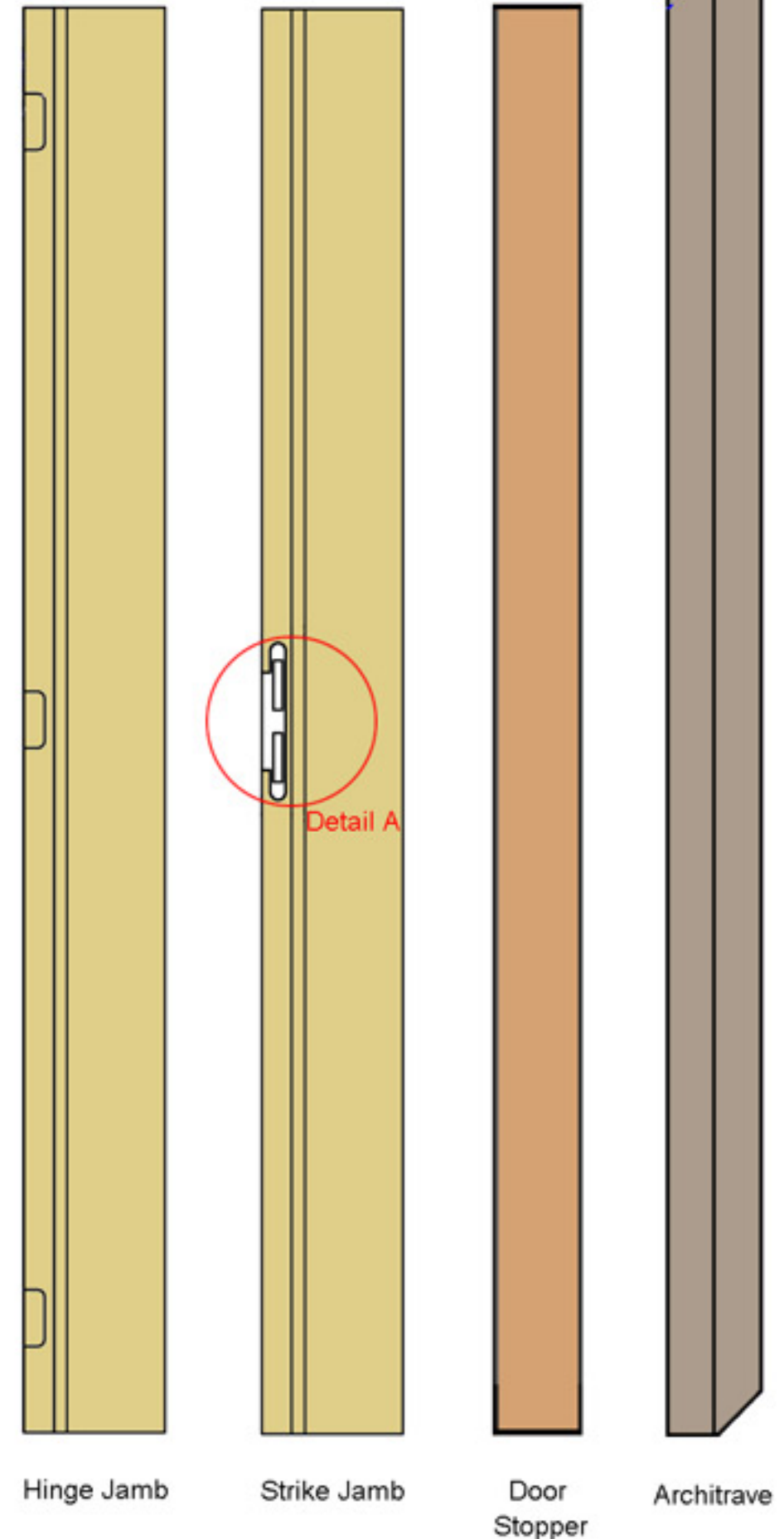
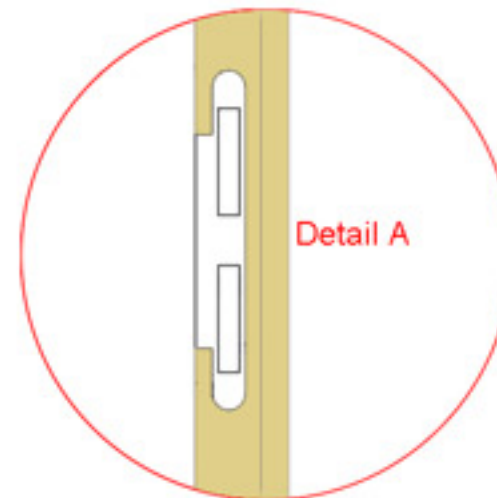

Hinge Jamb

Strike Jamb

Door Stopper

Architrave

## Specifications:

- Core: MDF+softwood (multiple hanging possible, moisture resistant)
- Face: wood veneered/ primed/ lacquered or oiled
- Finishing: same as complementary door

## Dimensions:

- ▶ Height: max. 2400mm
- ▶ Width: customized according to the wall thickness
- ▶ Thickness: min. 25mm
- ▶ Extension: max. 20mm on each side for adjusting towards the inaccuracy of the wall thickness and plastering

## Installation:

- ▶ Easy and fast installation (labor cost saving)
- ▶ Better nail holding strength
- ▶ More suitable for environments with higher moisture and t°

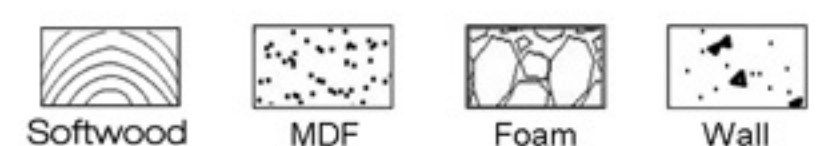
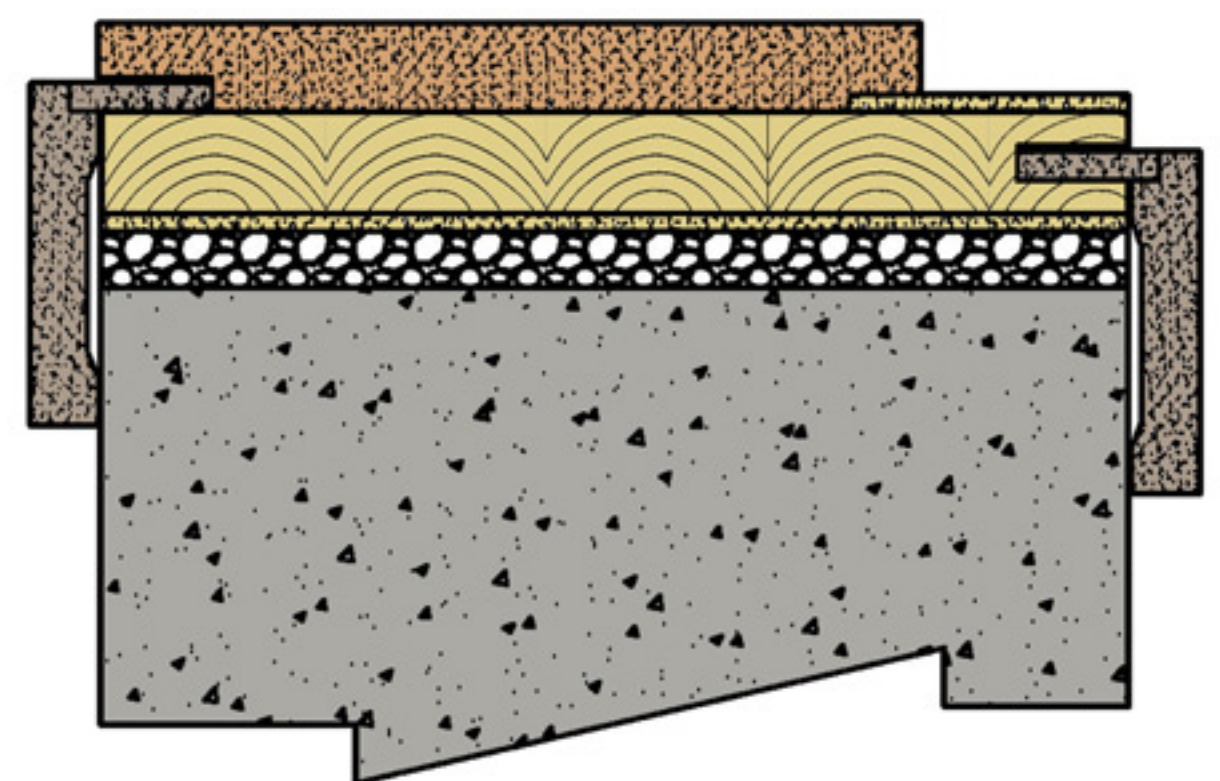
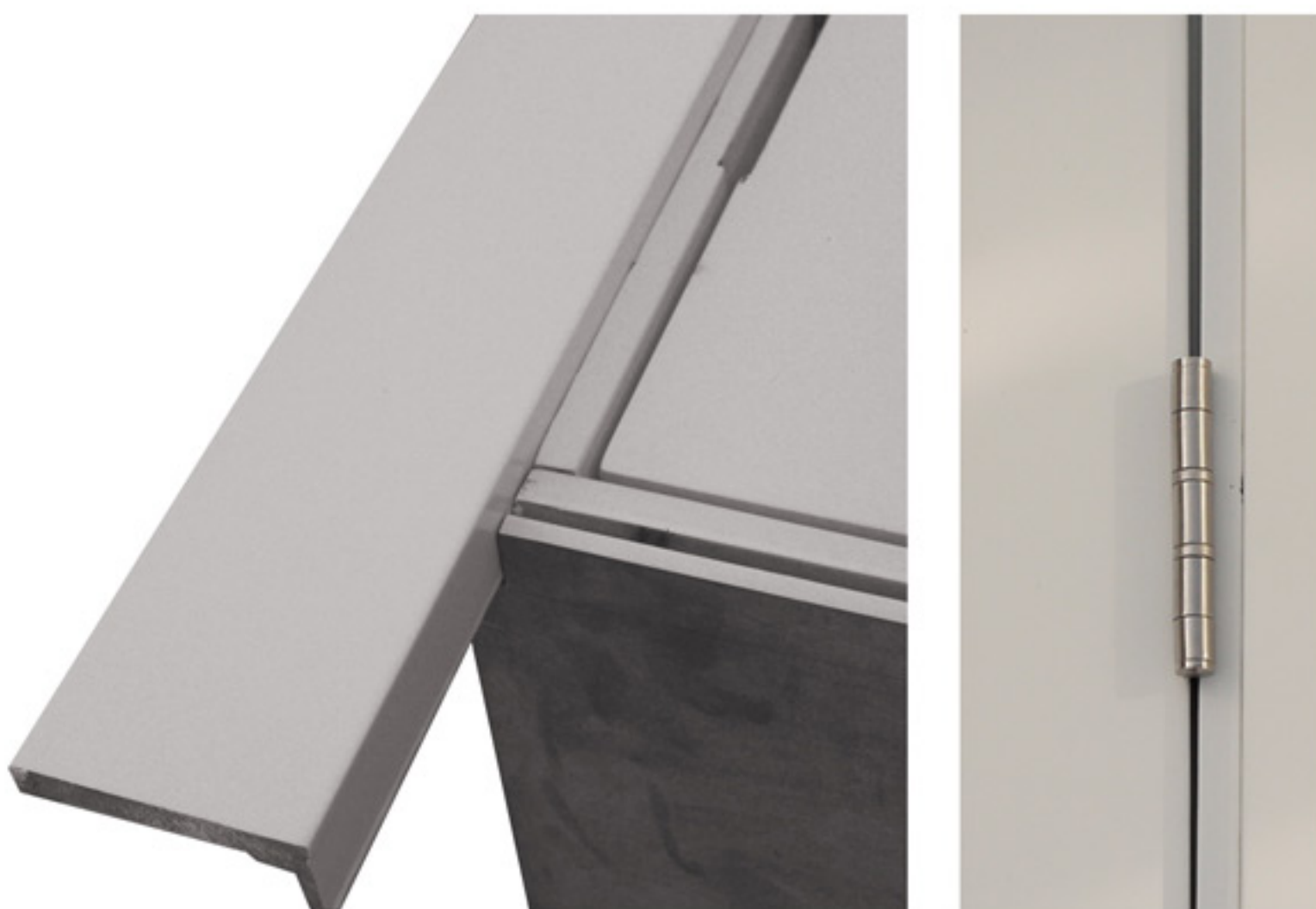

1. During this limited warranty, your ReTree products are warranted to be free from defects in manufacturing, materials and workmanship.
2. Should the Goods be defective and under the Seller's warranty, ReTree shall be obliged, at its sole discretion, either (i) to replace such Goods, or (ii) to reduce the product price or (iii) to cancel the said contract and take back the Goods. In case such Goods are not longer available, ReTree will ensure replacement by an alternative product of the same quality.
3. In any event the Seller shall not be liable for any loss of processing, loss of production, loss of revenue and/or any incidental or consequential or special loss or damage directly or indirectly sustained by the customer or by any other person whatsoever. Any obligation for damages shall be limited to foreseeable damages only, however, not to exceed the invoiced value of the Goods in respect of which the Seller is in default. It is the customer's responsibility to separate the Goods in default from the Goods conform the contract.
4. Upon Delivery of Goods, a complete inspection of the Goods shall be carried out. Any apparent damage to the packaging of the Goods or to the Goods themselves, or any shortage of the quantities shall be noted and communicated promptly to the Seller in writing by fax or legally signed e-mail.

The Goods shall be considered automatically accepted upon Delivery if the customer fails to make any comments in writing in respect thereof not later than 15 days after their Delivery. Any claim in respect of any defect, deficiency and/or shortage in quantity of the Goods after this period shall be statute-barred.

5. Undetectable defects at Delivery must be notified in writing to the Seller immediately upon discovery, but, in any event, no later than 30 days after Delivery. After this period, during which the customer must thoroughly inspect the Goods, any claim in respect of such defects shall be statute-barred.

ReTree products are built to be durable and long lasting. There are certain conditions or applications, however, over which ReTree has no control. Defects or problems as a result of such conditions or applications are not the responsibility of ReTree and are NOT covered under this warranty.

They include:

- ▶ The Goods have not been fitted in accordance with the installation instructions.
- ▶ Any misuse, modification or alternation.
- ▶ Normal wear or discoloration of finishes.
- ▶ Environmental conditions or exceeding design standards
- ▶ Natural variations in the colors of the wood or in the texture and grain of wood.
- ▶ This limited warranty does not cover, in any way, problems or damages associated with, caused by, contributed to or aggravated by mold, mildew, fungus or any similar organisms.
- ▶ Wood is a natural product and susceptible To expansion and contraction caused by temperature and humidity variation. The natural characteristics of wood movement can not be warranted against, as slight shrinking and expansion may occur under certain conditions. These deviations from perfection are not considered flaws. ReTree's installations instructions must be followed to minimize the problems.

